



6

Exhaust



World's Finest Products For Harley-Davidsons

EXHAUST



650012



651102

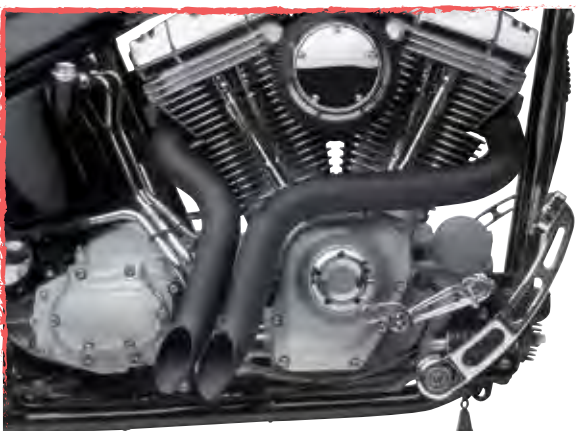

6



650366

650364

Santee "Designer Series" L.A.F. Pipes'

Created for Custom Chrome by John Reed to make a statement and make it with authority, unless your neighbors are bikers too, you're going to ruffle some feathers with these pipes! Available in 1 3/4" and 2" with either a chrome or black finish.

Softail Models

- 11447** 1 3/4" for Softail models 86-11, chrome
- 650387** 1 3/4" for Softail models 86-11, black
- 651045** 1 3/4" for Softail models 12-Up, chrome
- 651046** 1 3/4" for Softail models 12-Up, black
- 650010** 2" for Softail models 86-11, chrome
- 650317** 2" for Softail models 86-11, black
- 651047** 2" for Softail models 12-Up, chrome
- 651048** 2" for Softail models 12-Up, black

Shovelhead & Panhead Models

- 650012** 2" for 71-84 FX and 81-84 FL Shovelheads, chrome
- 650388** 2" for 71-84 FX and 81-84 FL Shovelheads, black
- 650367** 1 3/4" pipes for Pandemonium & Jammer 88 Shovelheads or Pan/Shovel with STD cylinder heads, chrome

Sportster Models

- 651102** 1 3/4" for Sportster models 04-Up, chrome
- 651103** 1 3/4" for Sportster models 04-Up, black



651104



Optional Heat Shields

- 650363** Optional chrome heat shields for #11447 & #651045
- 650364** Optional chrome heat shields for #650010 & #651047
- 650365** Optional chrome heat shields for #650012
- 650366** Optional chrome heat shields for #650367
- 651104** Optional chrome heat shields for #651102
- 651105** Optional black heat shields for #651103



APPAREL

SEATS & BAGS

FOOT CONTROLS

HAND CONTROLS

LIGHTING

ELECTRICAL

EXHAUST

INTAKE

ENGINE

GASKETS

TRANSMISSION & CLUTCH

DRIVELINE

WHEELS TIRES & BRAKES

CHASSIS

SHEETMETAL

FINISHMENTS & ACCESSORIES

GENERAL

CROSS REFERENCE

AVAILABLE IN BLACK



PAUL YAFFE ORIGINALS
DESIGN & DEVELOPMENT



651100



651110

Santee "Designer Series" 'Skirt Blower' Pipes by Paul Yaffe Originals

A classic upswept pipe design from the mind of Paul Yaffe. Straight up in your face styling with a multi-piece heat shield design that will totally set your bike apart from the crowd.

Softtail Models

- 600069** For Softtail models 86-11, chrome
- 650386** For Softtail models 86-11, black
- 651053** For Softtail models 12-Up, chrome
- 651054** For Softtail models 12-Up, black

Dyna Models

- 651112** For Dyna models 12-Up, chrome
- 651113** For Dyna models 12-Up, black
- 651110** For Dyna models 06-11, chrome
- 651111** For Dyna models 06-11, black

Sportster Models

- 651100** For Sportster models 04-Up, chrome
- 651101** For Sportster models 04-Up, black



600069

EXHAUST



AVAILABLE IN BLACK



650374

Santee "Designer Series" Double Barrel High Exhaust by Cycle Kraft

Designed by Kenji Nagai of Cycle Kraft Japan. These are the hottest pipes on the market, available in chrome or black finish with optional heat shields. Include billet steel end caps and baffles.

- 650374 Double Barrel High, chrome fits Softails 86-11
- 650375 Double Barrel High, black fits Softails 86-11
- 651058 Double Barrel High, chrome fits Softails 12-Up
- 651059 Double Barrel High, black fits Softails 12-Up
- 650376 Double Barrel High, heat shields, chrome
- 650377 Double Barrel High, heat shields, black

6



AVAILABLE IN BLACK



650378

Santee "Designer Series" Double Barrel Low Exhaust by Cycle Kraft

Designed by Kenji Nagai of Cycle Kraft Japan. This is the second version of his double barrel pipes, available in chrome or black finish with optional heat shields. Include billet steel end caps and baffles.

- 650378 Double Barrel Low, chrome fits Softails 86-11
- 650379 Double Barrel Low, black fits Softails 86-11
- 651056 Double Barrel Low, chrome fits Softails 12-Up
- 651057 Double Barrel Low, black fits Softails 12-Up
- 650380 Double Barrel Low heat shields, chrome
- 650381 Double Barrel Low, heat shields, black

EXHAUST



AVAILABLE IN BLACK



650370

Fastbacks Pipes for Softails by Custom Chrome

Custom Chrome's latest creation in exhaust designs. Choose between black or chrome finish, heat shields are available in either finish (sold separately) so you can mix and match to your taste.

- 650370** Fastbacks, chrome Softails 86-11
- 650371** Fastbacks, black Softails 86-11
- 651060** Fastbacks, chrome Softails 12-Up
- 651061** Fastbacks, black Softails 12-Up
- 650372** Fastbacks, chrome heat shields
- 650373** Fastbacks, black heat shields



650817

Santee 'Holeshot' Pipes for Sportsters

Midmount pipes designed to set your bike apart from the crowd. Available with black or chrome drilled heat shields and delivered with baffles and mounting hardware.

- 650817** Holeshot pipes 04-Up XL chrome
- 650818** Holeshot pipes 04-Up XL black



650818

- APPAREL
- SEATS & BAGS
- FOOT CONTROLS
- HAND CONTROLS
- LIGHTING
- ELECTRICAL
- EXHAUST**
- INTAKE
- ENGINE
- GASKETS
- TRANSMISSION & CLUTCH
- DRIVELINE
- WHEELS TIRES & BRAKES
- CHASSIS
- SHEETMETAL
- INSTRUMENTS & GAUGES
- GENERAL
- CROSS REFERENCE

EXHAUST

SANTEE



**NEW
FITMENTS**



AVAILABLE IN BLACK

650389



649608



651114



651106



650043

Santee 'Lake Pipes'

Styled after the classic Street-Rod side pipes, they must be seen and heard to be believed. They feature 2" head pipes constructed of 16 gauge steel and are available in a choice of 2 outlet lengths 5" or 11" (except Touring and Dyna models are only 11"-long outlets) as well as in either a chrome or black finish.

Touring Models

- 649608 11"-long outlet for Touring 99-Up, chrome
- 649609 11"-long outlet for Touring 99-Up, black
- 649610 11"-long outlet for Touring 93-98, chrome
- 649611 11"-long outlet for Touring 93-98, black

Softail Models

- 651041 5"-long outlet for Softails 12-Up, chrome
- 651042 5"-long outlet for Softails 12-Up, black
- 650042 5"-long outlet for Softails 86-11, chrome
- 650389 5"-long outlet for Softails 86-14, black
- 651043 11"-long outlet for Softails 12-Up, chrome
- 651044 11"-long outlet for Softails 12-Up, black
- 650043 11"-long outlet for Softails 86-14, chrome
- 650390 11"-long outlet for Softails 86-14, black

Note: Will not fit models with floorboards

Dyna Models

- 651116 11"-long outlet for Dynas 12-Up, chrome
- 651117 11"-long outlet for Dynas 12-Up, black
- 651114 11"-long outlet for Dynas 06-11, chrome
- 651115 11"-long outlet for Dynas 06-11, black

Sportster Models

- 651106 11"-long outlet for Sportsters 04-Up, chrome
- 651107 11"-long outlet for Sportsters 04-Up, black
- 651108 5"-long outlet for Sportsters 04-Up, chrome
- 651109 5"-long outlet for Sportsters 04-Up, black

EXHAUST



AVAILABLE IN BLACK



651122



651124



651126



651128



651130



651131

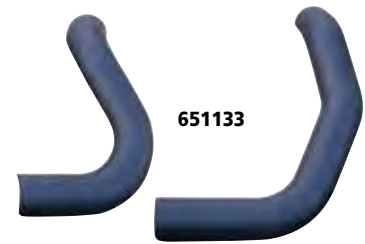

651133



651134



651135



651136

- APPAREL
- SEATS & BAGS
- FOOT CONTROLS
- HAND CONTROLS
- LIGHTING
- ELECTRICAL
- EXHAUST
- INTAKE
- ENGINE
- GASKETS
- TRANSMISSION & CLUTCH
- DRIVELINE
- WHEELS TIRES & BRAKES
- CHASSIS
- SHEETMETAL
- INSTRUMENTS & GAUGES
- GENERAL
- CROSS REFERENCE

Santee 225 Series Pipes for Sportster Models

Go big with Santee 225 series pipes! The 16-gauge 2 1/4" diameter seamless tubing is precision bent and then chrome-plated. They are designed to fit 86-14 Sportster models and optional heat shield sets and baffles with billet tips are available separately. Available in either a chrome-plated or black finish.

Short Cut 225's

- 651124** Short Cut pipes for 04-Up XL models, chrome
- 651125** Short Cut pipes for 04-Up XL models, black
- 651122** Short Cut pipes for 86-03 XL models, chrome
- 651123** Short Cut pipes for 86-03 XL models, black
- 651130** Chrome tip with baffle. Pair
- 651131** Black tip with baffle. Pair

Slash Cut 225's

- 651128** Slash Cut pipes for 04-Up XL models, chrome
- 651129** Slash Cut pipes for 04-Up XL models, black
- 651126** Slash Cut pipes for 86-03 XL models, chrome
- 651127** Slash Cut pipes for 86-03 XL models, black

Optional Heat Shields

- 651134** Chrome heat shields for 04-Up models
- 651133** Black heat shields for 04-Up models
- 651136** Chrome heat shields for 86-03 models
- 651135** Black heat shields for 86-03 models

EXHAUST



2 1/4" Drag Pipes

Go BIG with '225's from Santee! Huge 2 1/4"-diameter pipes deliver wicked sound and all the performance you can handle. Made from 16 gauge seamless tubing.

For Softail Models

07719 For Softail models 86-11, chrome

650383 For Softail models 86-11, Black



AVAILABLE IN BLACK

6



BIG BEAR CHOPPERS Venom



Santee "Designer Series" "Venom" Pipes by Big Bear Choppers

These 2" pipe sets are constructed of 14-gauge seamless tubing and feature extreme slash cut tips. They come complete with mounting brackets.

650029 'Venom' for stock Softail models 86-11.

651055 'Venom' for stock Softail models 12-Up

650028 'Venom' for Softail with right side drive 5/8" offset motor mounts 86-06.

650035 Chrome heat shield set



'Big Mama' Pipes for FX Softail Models from 84-Up

2 1/4" pipes featuring vertical slash cut tips which accent the angle of the swingarm. This unique set of show-chromed pipes provides a sleek custom look. Manufactured of heavy 16 gauge steel tubing, precision bent on computer controlled equipment and hand checked to ensure a perfect fit.

280142 For Softail models from 86-06.

650149 For Softail models 07-11

651052 For Softail models 12-Up



280142

EXHAUST



APPAREL

SEATS & BAGS

FOOT CONTROLS

HAND CONTROLS

LIGHTING

ELECTRICAL

EXHAUST

INTAKE

ENGINE

GASKETS

TRANSMISSION & CLUTCH

DRIVELINE

WHEELS TIRES & BRAKES

CHASSIS

SHEETMETAL

INSTRUMENTS & GAUGES

GENERAL

CROSS REFERENCE



07177

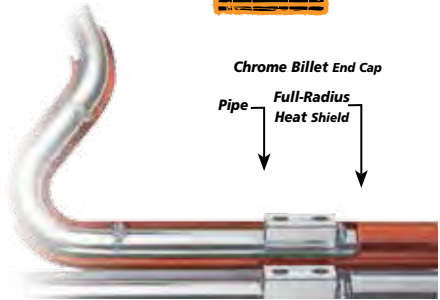

Santee 2 1/2" 'Snub Nose' Exhaust Pipes

Subtle as a nuclear blast — these pipes rock! Featuring fat 2 1/2" maximum coverage heat shields for a huge look that keeps your pipes looking new and virtually eliminates blueing. Each pipe is constructed of heavy-duty 16-gauge steel and include heavy-duty mounting brackets and chrome billet end caps with integral baffles complete the package. Like all Santee pipes these beauties are engineered to survive.

AVAILABLE IN BLACK

- 07177** For Softail models 86-11, chrome
- 650382** For Softail models 86-14 Black
- 650391** For Dyna models 06-11 chrome
- 650392** For Dyna models 06-11 black
- 650368** For Dyna models 12-Up chrome
- 650369** For Dyna models 12-Up black
- 650086** For Sportster models from 04-Up
- 651040** For Sportster models from 04-Up black



650160

650162



Santee "Designer Series" 'BOA'

Created with 2" pipe then beautifully polished and chromed, the BOA is a lethal combination of performance and style. For Softail models.

- 650160** For Softail models 86-06
- 651049** For Softail models 12-Up
- 650162** Optional chrome heat shield set with hardware



07721



650384

Santee Drag Pipes for Touring Models

Distinct dual exhaust systems featuring 2 1/4" straight pipes to deliver wicked sound and all the power you can handle. The 'Crossover' system has one pipe exiting on each side.

- 07721** Crossover exhaust system 89-06
- 650384** Crossover exhaust Chrome 10-Up
- 650385** Crossover exhaust Black 10-Up

EXHAUST



Santee 1 3/4" Drags

Dyno Power drag pipes add both style and performance. These smooth bracketless pipes may be mounted with 'P'-clamps or with the universal chrome exhaust mounting brackets listed below. Dyno Power drags accept baffles when quieter exhaust note is desired.

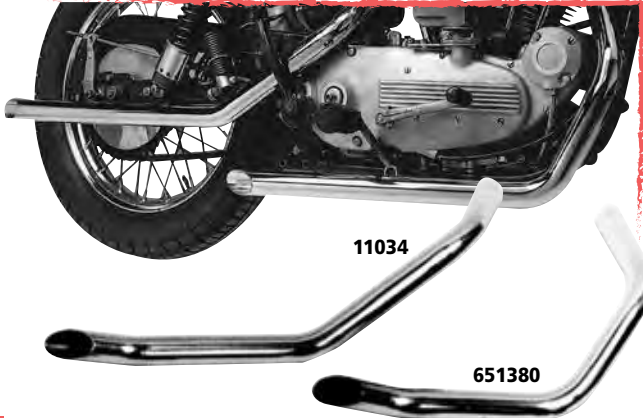

6

For Sportster models 57-85.

40"-long drag pipes mount using the universal drag pipe mounting brackets listed below. 80 and later models require optional Brake Pedal Stop. Will not fit XLCR, 79, or XR-1000 models.

- 11034** 1 3/4" Drag pipes 40" long
- 651369** 1 3/4" Straight drags 34" long
- 651380** 1 3/4" Goose Cut drags 34" long
- 11086** Mounting Bracket for 1 3/4" set
- 11229** 1 3/4"-diameter baffle



11048

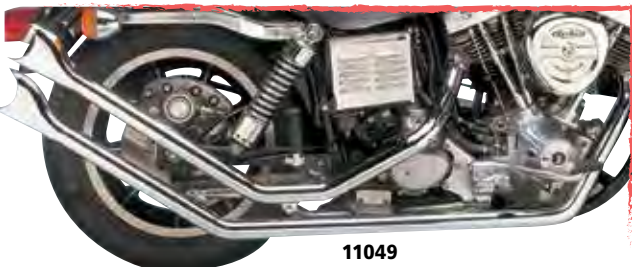

11049

Santee 1 3/4" Upswept Drag Pipes for 71-84 FX Models

These drag pipe sets are reminiscent of the 'chopper' pipes from the 60s. Available two ways; 'Kick-Out' style with a slick turned out look, or for real nostalgia choose the 'Trim-Tail' system. Chrome mounting bracket and hardware is included. Dyno Power pipes feature smooth, even mandrel bends and fully-polished high-quality chrome-plating.

- 11048** 'Kick-Out' Drags
- 11049** 'TrimTail' Drags

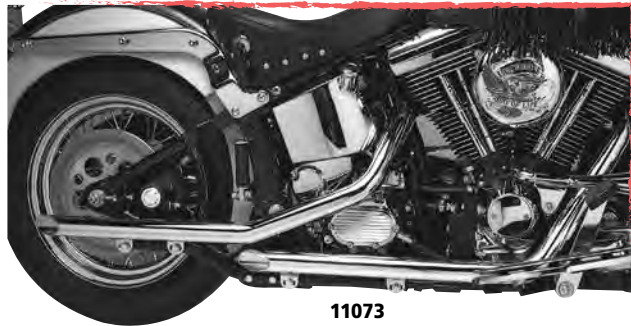

11073



11020

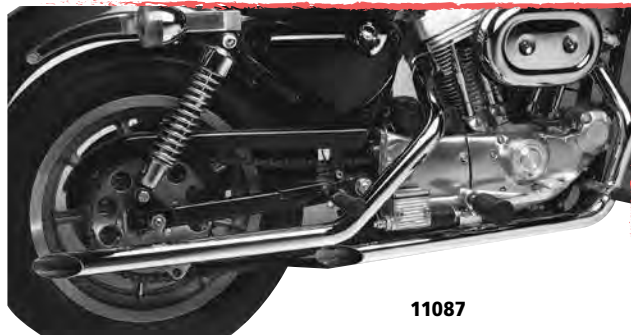

11087

Santee 1 3/4" Slash Cut Drag Pipes

Santee Drag pipes are made of 16 gauge steel with hidden channel mounts that connect to your stock brackets or to supplied brackets unless otherwise noted.

For Softail Models 84-11

- 11073** For Softail models 84-06 (except Fat Boy and FLSTN models)

- 650151** For Softail models from 07-11
- 11229** 1 3/4"-diameter baffle

For 4-Speed FX Models from 71-84.

- 11020** Slash-Cut Drags
- 11229** 1 3/4"-diameter baffle

For Sportster Models 86-03.

Front pipe mount includes integral brake pedal stop similar to stock. Pipes will not fit models with Original Equipment forward controls.

- 11087** Slash-Cut Drags
- 11928** Chrome front heat shield
- 11930** Chrome rear heat shield
- 11229** 1 3/4"-diameter baffle

EXHAUST



APPAREL

SEATS & BAGS

FOOT CONTROLS

HAND CONTROLS

LIGHTING

ELECTRICAL

EXHAUST

INTAKE

ENGINE

GASKETS

TRANSMISSION & CLUTCH

DRIVELINE

WHEELS TIRES & BRAKES

CHASSIS

SHEETMETAL

INSTRUMENTS & GAUGES

GENERAL

CROSS REFERENCE

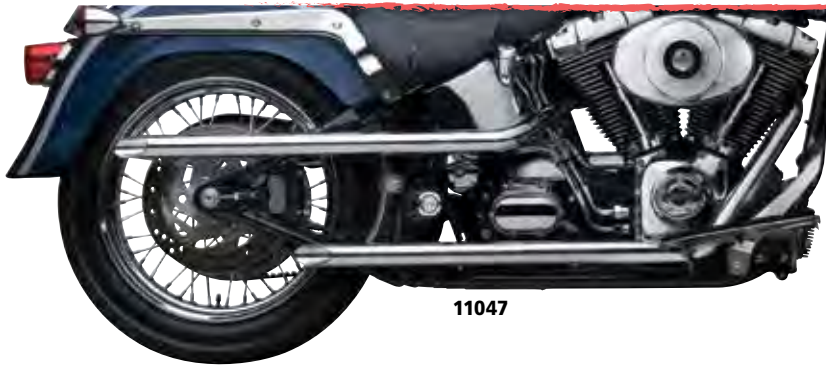

11047

1 3/4" Shotgun Drag Pipes

Classically styled high quality Shotgun Drags are made of 16 gauge steel with beautiful chrome plating, great bends and hot performance. Optional baffles may be used if a quieter exhaust note is desired.

11047 For Softail models 84-06.

650152 For Softail models from 07-11

11229 1 3/4"-diameter baffle

Note: The installation of this pipe set on Fat Boy and FLSTN models will require the removal of the stock rear exhaust pipe mounting bracket.



1 3/4" 'S'-Style Drag Pipes

These slick looking drags have an 'S' shaped rear pipe that crosses the transmission stacked above the front pipe. Available in a variety of styles, they are constructed of 16 gauge steel and feature flawless chrome plating. Each set uses hidden channel mounts and includes all necessary hardware and brackets except where noted otherwise.

'Shorty Kickdown' Drags for Softail Models from 86-06.

Includes an innovative chrome plated exhaust bracket that replaces the tubular Original Equipment part

11323 Slash-Cut Drags for Softail models 86-06.

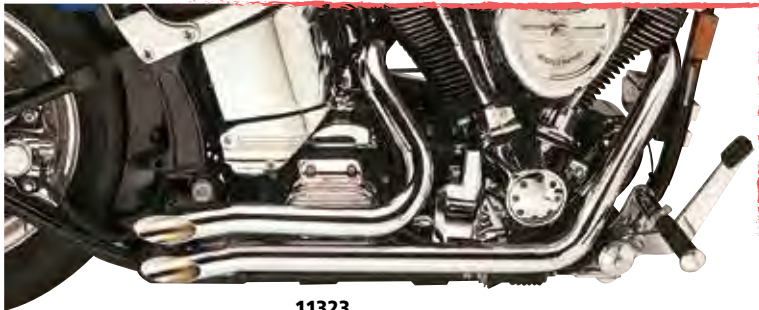

11323



For 4-Speed FL Models 70-84 (with kick or electric start)

40"-long drag pipe set has an inside-the-frame front pipe that fits with factory floorboards and forward-mounted master cylinder. The under-the-transmission rear pipe clears the large battery, factory safety bars and saddle bags. Easily mounted using optional 'P'-clamps. Floorboard models require an optional Floorboard Adaptor.

11038 1 3/4" Drag pipes

26312 Floorboard adaptor

11229 1 3/4"-diameter baffle

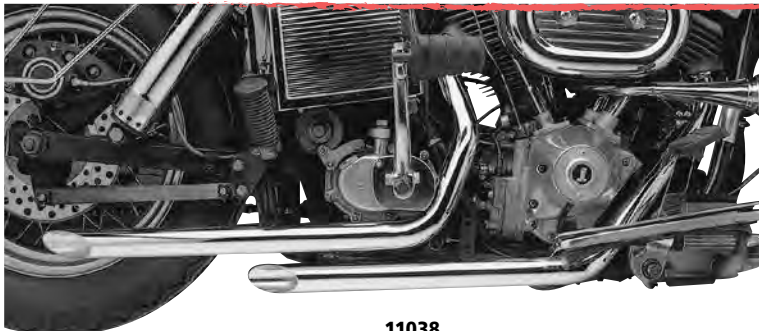

11038



For FX Models 71-84 and 4-Speed FL Models 81-84.

Clear all Original Equipment footpeg and control positions and provide superior fit with excellent ground clearance. Complete with concealed channel-mounts, chrome mounting bracket, exhaust port gaskets, sockethead exhaust port screws with lockwashers, and installation instructions. Optional baffles may be installed when a quieter exhaust note is desired.

11075 2" Slash-Cut Drags

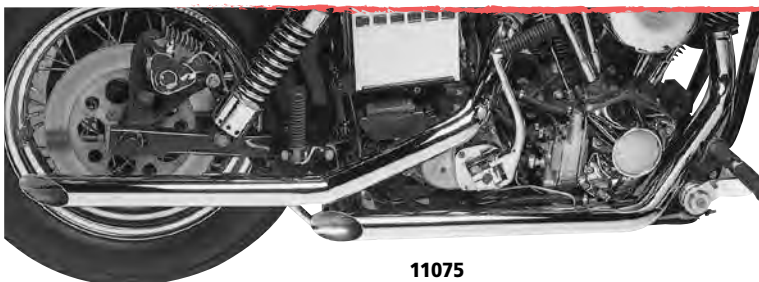

11075

EXHAUST



Santee Shotgun Pipe Builders Kit

For Pandemonium & Jammer 88" Shovelheads or Panl Shovelheads with STD Cylinder Heads

This is the perfect starting point for those one off Shotgun pipes you are looking to build. They are designed to work perfectly with our Pandemonium, Jammer 88" Shovelhead or any Panhead/Shovelhead with STD cylinder heads. This kit comes complete with a front & rear pipe with flanges pre-welded on and 2 channel mounts that can be welded on where-ever you need them. The pipes come in a raw steel so you can cut and weld them up and chrome, paint, or wrap them up however you like. Made in the U.S.A.

650155 Santee Shotgun pipe builders kit.



Kibblewhite Exhaust Spigot for Panhead Models

Repair mangled exhaust spigots. Machined from 6061-T6 extruded tube. Welding required.

Sold each.

55165 Fits all Panhead motors 48-64

6



Santee Fishtail Straight Pipes

A set of unmuffled, 30"-long Fishtail straight pipes with 1 3/4"-inlets.

11402 Fishtail straight pipes, Sold in pairs



Santee Baffled Fishtail Extensions

These 36"-long universal Fishtail extensions can be easily added to existing headpipes. Sold each.

15971 1 3/4"-inlet



Classic Fishtail Muffler

Show-chrome muffler with an antique-style tip. This clean, bracketless muffler allows left or right side mounting and has a 1 3/4"-inlet, and is 35"-long. Sold each.

11419 Fishtail muffler



Universal Perforated Exhaust Heat Shield

Chrome-plated 11"-long universal heat shield fits a range of pipe and muffler sizes from 1 3/4" to 3". Ideal for Shotgun or upswept exhaust systems. Sold each.

08877 Heat shield



Chrome Exhaust Heat Shield

7" chrome-plated heat shield for all 1 3/4" diameter exhaust pipes. A unique integrated clamp mounts this shield for a neat custom appearance.

15980 Chrome heat shield

688083 Chrome drilled heat shield

688078 Black 7" heat shield



Universal Exhaust Pipe Heat Shield

7"-long universal heat shield fits a range of pipe sizes from 1 1/2" to 2". Ideal for protection on Shotgun or upswept systems. Sold each.

15990 Universal heat shield



Floorboard Adaptor

Required for use when installing some Santee exhaust systems on 4-speed FL models equipped with floorboards. When properly installed, it provides additional clearance between the front pipe and the right floorboard. Sold each.

26312 Floorboard adaptor

EXHAUST



Exhaust End Caps by Custom Chrome

To complement the ever popular 3.5" Rinehart mufflers we've come up with some stylish replacement end caps. Whether yours are scratched, faded or you just want to change the look of your mufflers we have something for you. We even have a raw slug that you can powder coat, anodize, machine or do whatever you like to. End caps are sold each and have a chrome or black Teflon coating.

- 697410** 3.5" End cap Vortex chrome
- 697411** 3.5" End cap Vortex black
- 697412** 3.5" End cap Afterburner
- 697413** 3.5" End cap Smoothie raw
- 697414** 3.5" End cap Bullet chrome
- 697415** 3.5" End cap Bullet black
- 697416** 3.5" End cap Thruster chrome
- 697417** 3.5" End cap Thruster black



Santee 2-Into-1 Headpipes for Softail Models 86-06.

Modeled after the early-style 2-into-1 exhaust systems, the two separate front and rear 1 3/4" headers are joined with a tooled slip-fit connection for a snug, leak-resistant seal that requires no external clamping. This pipe set allows you to build a custom system and includes a muffler clamp and mounting bracket. Provides generous ground clearance and won't interfere with Original Equipment floorboards, controls, footpegs or saddlebags.

11180 2-into-1 headpipe set

- APPAREL
- SEATS & BAGS
- FOOT CONTROLS
- HAND CONTROLS
- LIGHTING
- ELECTRICAL
- EXHAUST**
- INTAKE
- ENGINE
- GASKETS
- TRANSMISSION & CLUTCH
- DRIVELINE
- WHEELS TIRES & BRAKES
- CHASSIS
- SHEETMETAL
- INSTRUMENTS & GAUGES
- GENERAL
- CROSS REFERENCE

EXHAUST

FREEDOM
PERFORMANCE
exhaust

NEW



689693



689684



689685



689694



689690

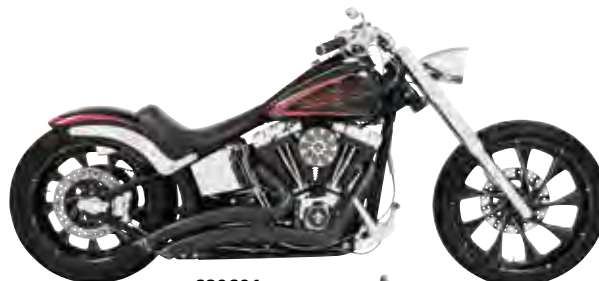

689691



689681



689682

6

Sharp Curve Radius Exhaust System With End Caps by Freedom Performance

The Sharp Curve Radius is a blend of great looks, performance and quality that you have come to expect from Freedom Performance now has decorative end caps in chrome or black. Each system comes complete with Large 2-1/2" 16 gauge heavy duty 220° blue proof 1-piece full length heat shields prevent chipping, rust and peeling between sections. O2 ports & plugs provided for early models. Complete with mounting hardware and brackets. Made in the U.S.A.

Touring Models

689692 Chrome Pipes with Chrome End Caps for Touring models 95-Up

689693 Chrome Pipes with Black End Caps for Touring models 95-Up

689694 Black Pipes with Black End Caps for Touring models 95-Up

Softail Models (Except Rocker & Breakout models)

689689 Chrome Pipes with Chrome End Caps for Softail models 86-Up

689690 Chrome Pipes with Black End Caps for Softail models 86-Up

689691 Black Pipes with Black End Caps for Softail models 86-Up

Dyna Models

689683 Chrome Pipes with Chrome End Caps for Dyna models 06-Up

689684 Chrome Pipes with Black End Caps for Dyna models 06-Up

689685 Black Pipes with Black End Caps for Dyna models 06-Up

689686 Chrome Pipes with Chrome End Caps for Dyna models 91-05

689687 Chrome Pipes with Black End Caps for Dyna models 91-05

689688 Black Pipes with Black End Caps for Dyna models 91-05

Sportster Models

689680 Chrome Pipes with Chrome End Caps for Sportster models 04-Up

689681 Chrome Pipes with Black End Caps for Sportster models 04-Up

689682 Black Pipes with Black End Caps for Sportster models 04-Up

EXHAUST



689888

Feel the Power of
Freedom



689890

'American Outlaw' True Dual Systems by Freedom Performance

This is the world's only 5-step 4 1/2" Megaphone dresser exhaust system. It features triple stepped headers for anti-reversion, full range torque and optimal horsepower. Includes full-length, 1 piece 220 degree heat-shields. Deep throaty sound.

Systems for 09-Up Touring models

689888 Chrome body, chrome tip

689890 Chrome body, black tip

689892 Black body, black tip

APPAREL

SEATS &
BAGS

FOOT
CONTROLS

HAND
CONTROLS

LIGHTING

ELECTRICAL

EXHAUST

INTAKE

ENGINE

GASKETS

TRANSMISSION
& CLUTCH

DRIVELINE

WHEELS
TIRES &
BRAKES

CHASSIS

SHEETMETAL

INSTRUMENTS
& GAUGES

GENERAL

CROSS
REFERENCE

EXHAUST



689767 with 689807

True Duals Headers for Touring Models by Freedom Performance

These true duals complement the look of your touring bike, running two independent head pipes, one for the right and one for the left side, this system both sounds and looks awesome. These head pipes will work with both OEM and most aftermarket slip-on mufflers, giving you a wider variety of choices to customize your exhaust to fit your style. Header kits include front & rear pipes, all necessary mounting hardware and full coverage heat shields "Feel The Power Of Freedom!" Sold each.

689767 Fits all Touring models 95-08 - chrome

689818 Fits all Touring models 95-08 - black

689853 Fits all 09-Up Touring models chrome

689854 Fits all 09-Up Touring models black

Note: O2 sensor port bungs installed and O2 sensor port plugs included EXCEPT on any models that come standard with O2 sensors.

6



689820 with 689879

'Tuck & Under' Header System by Freedom Performance

Want to upgrade the sound and performance of your Bagger? So did the crew over at Freedom Performance. The 'Tuck & Under' True Dual Header system will work with both OEM mufflers and just about any aftermarket mufflers out there. All kits include front & rear head pipes, all necessary mounting hardware and full coverage heat shields. Fits all 95-13 FLHT/FLHR/FLHX/FLTR models. **689901** Chrome headers 95-08

689902 Headers with black ceramic coated heat shields 95-08

689880 Chrome headers 09-Up

689820 Headers with black ceramic coated heat shields 09-Up



EXHAUST



689932



APPAREL
SEATS & BAGS
FOOT CONTROLS
HAND CONTROLS
LIGHTING
ELECTRICAL

EXHAUST

INTAKE

ENGINE

GASKETS

TRANSMISSION & CLUTCH

WHEELS
TIRES &
BRAKES

CHASSIS

SHEETMETAL

INSTRUMENTS
& GAUGES

GENERAL

CROSS
REFERENCE

Eagle Slip-Ons by Freedom Performance

These 4" performance slip-ons are not only the best sounding slip-ons you can bolt on your bike, their stepped baffle design also gives you an unmatched performance gain. The unique baffle design also prevents any hot spots in the muffler to eliminate bluing.

- Two Step Baffle "Power Thrust"
- Removable Baffle For Optional "Quiet Baffle"
- Stylish, Sexy Rolled Edge Billet End Cap Offered In Ceramic Black Or Chrome
- Offered In All Chrome, Chrome Black Tip, Or All Black
- Triple Nickel Show Chrome
- Deep Throaty Sound
- Increase Of Power W/Crisp Throttle Response!

689931 Eagle slip-ons all chrome, FLT 95-Up

689932 Eagle slip-ons chrome body/black tip, FLT 95-Up

689933 Eagle slip-ons all black, FLT 95-Up



689960



689961



689962

'Combat' Slip-Ons by Freedom Performance

These 4 1/2" steel and billet mufflers were built for battle! These mufflers not only look good but were designed to increase power and add a throaty sound to your bike. Sold in pairs for use with stock headers or Freedom Performance True Dual headers. Fits all Touring models 95-Up.

689960 Combat slip-ons chrome body, chrome tip

689961 Combat slip-ons chrome body, black tip

689962 Combat slip-ons black body, black tip



689807



Freedom Performance Slip-On Mufflers

The guys at Freedom Performance have developed a line of slip-on mufflers that fits their True Dual Headers like a glove and will also fit your OEM headers as well. Includes a removable performance baffles. Fits all touring models 95-Up. Sold in pairs.

689804 4" Inverted Slash cut slip-on muffler chrome

689807 4" Classic Slash cut slip-on muffler chrome



EXHAUST



689821



689822



689823



689879



4 inch Racing Series Slip-On Mufflers by Freedom Performance

Bigger is always better, especially when it comes to your exhaust. The guys at Freedom Performance thought so too, that is why they developed their new 4" performance slip-on mufflers. These mufflers are available in either a chrome-plated or black ceramic finish and feature a removable performance baffle. Fit all Touring models from 95-Up. Sold in pairs.

689821 Chrome with chrome tip

689822 Chrome with black tip

689879 Black ceramic coated with black tip

689823 Black ceramic coated with chrome tip

6



Independence Exhaust Systems

Don't let the traditional drag pipe look fool you, these pipes are all about performance. Available in a LG (long) and a Shorty version as well as in a chrome or ceramic black finish. Each system comes complete with massive 2.5" blue-proof heat shields, removable baffles and stainless hardware.

Patriot LG Exhaust System

All the same feature and performance of the Independence systems but with a 45° slash cut just for a little added style.

Chrome-plated Systems

689727 Fits all Dyna models 91-05



689895



689896



689897

'American Outlaw' Slip-ons by Freedom Performance

These 4 1/2" megaphone slip-ons deliver incredible looks in addition to increased power and a crisp throttle response, accompanied by a deep throaty rumble. Sold in pairs for stock headers or Freedom dual headers.

Fits all Touring models 95-Up

689895 American Outlaw slip-ons chrome body, chrome tip

689896 American Outlaw slip-ons chrome body, black tip

689897 American Outlaw slip-ons black body, black tip

EXHAUST



689882

- APPAREL
- SEATS & BAGS
- FOOT CONTROLS
- HAND CONTROLS
- LIGHTING
- ELECTRICAL

EXHAUST

- INTAKE
- ENGINE

- GASKETS
- TRANSMISSION & CLUTCH

DRIVELINE

- WHEELS TIRES & BRAKES

CHASSIS

SHEETMETAL

- INSTRUMENTS & GAUGES

GENERAL

- CROSS REFERENCE



Sharp Curve Radius Exhaust System by Freedom Performance

The latest design from Freedom Performance. The Sharp Curve Radius is a blend of great looks, performance and quality that you have come to expect from Freedom Performance. Each system comes complete with 'blue-proof' heat shields and all necessary hardware. Made in the U.S.A.

Softail Models

- 689882 Softail Models 86-Up (except Rocker), chrome
- 689827 Softail Models 86-Up (except Rocker), black

Dyna Models

- 689836 Dyna Models 06-Up, chrome
- 689837 Dyna Models 06-Up, black
- 689903 Dyna models 91-05, chrome
- 689904 Dyna Models 91-05, black

Sportster Models

- 689934 2014 Sportster models, chrome
- 689935 2014 Sportster models, black
- 689920 Sportster models 04-13, chrome
- 689921 Sportster models 04-13, black



689827



689836



689837



689920

EXHAUST



689941



689958

Sharp Curve Radius High Exhaust System by Freedom Performance

The latest design from Freedom Performance. The Sharp Curve Radius High is a blend of great looks, performance and quality that you have come to expect from Freedom Performance. Each system comes complete with 'blue-proof' heat shields and all necessary hardware. Made in the U.S.A.

For Touring Models

689958 95-Up Touring models, chrome

689959 95-Up Touring models, black

For Softail Models

689940 86-Up Softail models (except Rocker), chrome

689941 86-Up Softail models (except Rocker), black

For Dyna Models

689938 06-Up Dyna models, chrome

689939 06-Up Dyna models, black

For Sportster Models

689936 04-Up Sportster models, chrome

689937 04-Up Sportster models, black



689937

6



689963



Staggered Dual Exhaust Systems by Freedom Performance

Don't let the traditional staggered pipe look fool you, these pipes are all about performance. These system features massive 2.5" blue-proof heat shields, removable baffles and stainless hardware and are available in a chrome or ceramic black finish. Made in the U.S.A.

Softail Models

689967 Fits all 86-Up Softail models, chrome

689968 Fits all 86-Up Softail models, black

Dyna Models

689965 Fits all Dyna models 06-Up, chrome

689966 Fits all Dyna models 06-Up, black

Sportster Models

689963 Fits all 04-Up Sportster models, chrome

689964 Fits all 04-Up Sportster models, black



689964



EXHAUST



689922



689923

APPAREL
SEATS & BAGS
FOOT CONTROLS
HAND CONTROLS

'American Outlaw' 2 into 1 Pipe by Freedom Performance

The world's only 5-step, 4 1/2" megaphone, 2 into 1 exhaust system for Sportsters. Available with heat-shields or without for those who want to wrap the header for that high-performance look. Fits forward and mid-controls and includes all necessary mounting hardware.

With Heat Shields

- 689951 2014 XL models, chrome
- 689950 2014 XL models, black
- 689922 04-Up XL models, chrome
- 689923 04-Up XL models, black

Without Heat Shields

- 689952 2014 XL models, chrome
- 689953 2014 XL models, black
- 689954 04-Up XL models, chrome
- 689955 04-Up XL models, black



689955

LIGHTING
ELECTRICAL
INTAKE

Exhaust Wrap Available Separately



689851



689852

ENGINE
GASKETS
TRANSMISSION
CLUTCH
DRIVELINE
HEELS
& KICKERS
CHASSIS



689758

'Union' 2-into-1 Exhaust System

The Union is a complete package of good looks, race inspired performance and an awesome sound! With a fit and finish like no other 2-into-1 system and is available in either a chrome or ceramic black finish. Each system comes complete with massive 2.5" blue-proof heat shields, removable baffles and stainless. Each system comes complete with 220° full coverage heat shields, mounting brackets and stainless hardware.

Chrome-plated Systems

- 689851 Fits all 95-Up Touring models
- 689758 Fits all Dyna models 06-13

Ceramic-Black Systems

- 689852 Fits all 95-Up Touring models

*2009 models will require the separate purchase of #689826 hardware kit

SHEETMETAL
INSTRUMENTS
& GAUGES
GENERAL

CROSS
REFERENCE

EXHAUST



689757

6



689720



689722



689748

Amendment Exhaust Systems By Freedom Performance

Don't let the drag pipe look fool you, these pipes are all about performance. The Amendment features massive 2.5" blue-proof heat shields, removable baffles and stainless hardware and are available in a chrome or ceramic black finish. Made in the U.S.A.

Dyna Models

- 689757 Fits all Dyna models 06-Up, chrome
- 689748 Fits all Dyna models 06-Up, black
- 689729 Fits all Dyna models 91-05, chrome
- 689762 Fits all Dyna models 91-05, black

Sportster Models

- 689948 Fits all 2014 Sportster models, chrome
- 689949 Fits all 2014 Sportster models, black
- 689720 Fits all Sportster models 04-13, chrome
- 689722 Fits all Sportster models 04-13, black

EXHAUST



689795

True Dual Systems for Softail by Freedom Performance

This is not your average 2-into-2 exhaust system. Freedom True-Duals are the most stunning display of engineering and precision on the market, consisting of blue-proof heat-shield technology throughout the entire pipe and stainless steel hardware for muscle. Freedom also finishes every performance exhaust system with their signature show-stopping chrome plated finish or black ceramic coated on some models. "Feel the power of Freedom" while you burn asphalt with the true duals power.

One Piece True Duals with 36" Sharktails

689794 True Dual 36" Sharktails for all Softail models 97-06

689795 True Dual 36" Sharktails for all Softail models 07-Up

One Piece True Duals with 32" Sharktails

689788 True Dual 32" Sharktails for all Softail models 97-06

689789 True Dual 32" Sharktails for all Softail models 07-Up

Note: O2 sensor port bungs installed and O2 sensor port plugs included EXCEPT on any models that come standard with O2 sensors. Bung plugs can be purchased separately CCI # 689707



689789



Independence Exhaust Systems by Freedom Performance

Don't let the traditional drag pipe look fool you, these pipes are all about performance. The Independence system features massive 2.5" blue-proof heat shields, removable baffles and stainless hardware and are available in a chrome or ceramic black finish. Made in the U.S.A.

Dyna Models

689799 Fits all Dyna models 06-Up, chrome

689798 Fits all Dyna models 06-Up, black

689766 Fits all Dyna models 91-05, chrome

689800 Fits all Dyna models 91-05, black

Sportster Models

689946 Fits all 2014 Sportster models, chrome

689947 Fits all 2014 Sportster models, black

689956 Fits all 04-13 Sportster models, chrome

689957 Fits all 04-13 Sportster models, black



689799

- APPAREL
- SEATS & BAGS
- FOOT CONTROLS
- HAND CONTROLS
- LIGHTING
- ELECTRICAL
- EXHAUST
- ENGINE
- GASKETS
- TRANSMISSION & CLUTCH
- DRIVELINE
- WHEELS TIRES & BRAKES
- CHASSIS
- SHEETMETAL
- INSTRUMENTS & GAUGES
- GENERAL
- CROSS REFERENCE

EXHAUST



689924



689916

Racing Series Slip-On Mufflers by Freedom Performance

Freedom Performance Signature Series slip-on mufflers are great alternative to replacing your entire exhaust system. These mufflers were designed to increase performance while giving your bike that 'throaty' sound you are looking for and best of all you can do this without breaking the bank. Available for a variety of Big Twins and Sportster models. Made in the U.S.A.

For Softail Models

- 689911** Chrome with chrome tip for 07-Up FLSTF & FXSTD models
- 689914** Chrome with black tip for 07-Up FLSTF & FXSTD models
- 689912** Chrome with chrome tip for 07-Up FLSTN & FLSTSB models
- 689915** Chrome with black tip for 07-Up FLSTN & FLSTSB models
- 689918** Black with black tip for 07-13 FLSTN & FLSTSB models
- 689913** Chrome with chrome tip for 07-Up FXST, FXSTB, FXSTS/S, FLST, FLSTC, FXCW/C models
- 689916** Chrome with black tip for 07-Up FXST, FXSTB, FXSTS/S, FLST, FLSTC, FXCW/C models

For Dyna Models

- 689905** Chrome with chrome tip for 91-Up FXD & FXDWG models (except FXDF, FXDWG 10-Up)
- 689906** Chrome with black tip for 91-Up FXD & FXDWG models (except FXDF, FXDWG 10-Up)
- 689907** Chrome with chrome tip for 08-Up FXDF, FXDWG 10-Up models
- 689908** Chrome with black tip for 08-Up FXDF, FXDWG 10-Up models

For Sportster Models

- 689944** Racing Series mufflers chrome with chrome tip for 2014 XL models
- 689945** Racing Series mufflers chrome with black tip for 2014 XL models
- 689924** Chrome with chrome tip for 04-13 XL models
- 689925** Chrome with black tip for 04-13 XL models
- 689926** Black with black tip for 04-13 XL models

6



689872



689869

Signature Series Slip-On Mufflers by Freedom Performance

Freedom Performance Signature Series slip-on mufflers are great alternative to replacing your entire exhaust system. These mufflers were designed to increase performance while giving your bike that 'throaty' sound you are looking for and best of all you can do this without breaking the bank. Available for a variety of Big Twins and Sportster models. Made in the U.S.A.

For Softail Models

- 689863** Chrome with chrome tip for 07-Up FLSTF & FXSTD models
- 689866** Chrome with black tip for 07-Up FLSTF & FXSTD models
- 689864** Chrome with chrome tip for 07-Up FLSTN & FLSTSB models
- 689867** Chrome with black tip for 07-Up FLSTN & FLSTSB models
- 689865** Chrome with chrome tip for 07-Up FXST, FXSTB, FXSTS/S, FLST, FLSTC, FXCW/C models
- 689868** Chrome with black tip for 07-Up FXST, FXSTB, FXSTS/S, FLST, FLSTC, FXCW/C models

For Dyna Models

- 689869** Chrome with chrome tip for 91-Up FXD & FXDWG models (except FXDF and 10- FXDWG)
- 689870** Chrome with black tip for 91-Up FXD & FXDWG models (except FXDF and 10- FXDWG)
- 689871** Chrome with chrome tip for 08-Up FXDF, FXDWG 10-Up models
- 689872** Chrome with black tip for 08-Up FXDF, FXDWG 10-Up models

For Sportster Models

- 689942** Chrome with chrome tip for 2014 XL models
- 689943** Chrome with black tip for 2014 XL models
- 689873** Chrome with chrome tip for 04-13 XL models
- 689874** Chrome with black tip for 04-13 XL models
- 689927** Black with black tip for 04-13 XL models

EXHAUST



689929



689930

Slip-ons for V-Rods by Freedom Performance

Add some low end torque and tons of power to your Night Rod with these 4" mufflers. They come with black or chrome end caps, complete with mounting hardware and brackets for stock headers. Fit Night Rod 06-08 and Night Rod Special from 07-Up.

- 689928 Chrome with chrome tip
- 689929 Chrome with black tip
- 689930 Chrome with chrome tip



689849

Freedom Performance 'Racing Duals' System

This system is designed around a triple step header design with a 2.5" racing baffle for big inch applications. Sold as complete system.

- 689849 Fits all 09-13 Touring models chrome with black tip

APPAREL

SEATS & BAGS

FOOT CONTROLS

HAND CONTROLS

LIGHTING

ELECTRICAL

EXHAUST

INTAKE

ENGINE

GASKETS

TRANSMISSION & CLUTCH

DRIVELINE

WHEELS TIRES & BRAKES

CHASSIS

SHEETMETAL

INSTRUMENTS & GAUGES

GENERAL

CROSS REFERENCE

EXHAUST



664607



SuperTrapp 2:1 SuperMegs

Features a triple chrome plated or black ceramic coated mild steel tuneable disc system for increased noise absorption and durability. Dyno tests have shown the new 2:1 system outperforms all 2:1 systems on the market. Mounting system is bracketed to transmission so it floats with the assembly, eliminating flexing and potential cracking. Each set includes a three piece heat shield.

- 664606 For Touring models 09*, Chrome
- 664607 For Touring models 09*, Black
- 664070 For 10-13 Touring models, Chrome
- 664071 For 10-13 Touring models, Black
- 280435 For Touring models 07-08*, Chrome
- 664042 For Touring models from 07-08*, Black
- 280434 For Touring models 85-06, Chrome
- 664043 For Touring models from 85-06, Black
- 280437 For Dyna Glide models 06-14*, Chrome

- 664046 For Dyna Glide models from 06-11*, Black
- 280429 For Dyna 91-05, Chrome
- 664044 For Dyna from 91-05, Black
- 280436 For Softail models 84-14*, Chrome
- 664045 For Softail models from 84-13*, Black
- 664047 For Sportster models 04-13*, Chrome
- 664048 For Sportster models 04-13*, Black

Note: * Includes O2 sensor port

6

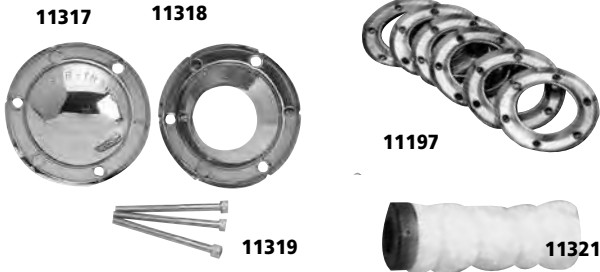

SuperTrapp 3" Internal Disc Series Accessories Replacement Parts

- 11319 Screw kit for three-bolt style muffler cores (pack of three) Stainless steel screws for 8 up to 22 discs
- 11197 3" diffuser discs (pack of six)
- 11321 Core assembly with packing for all staggered dual systems and universal mufflers. May be used to replace center-bolt style cores (except CC #11147)
- 11317 Closed end cap for 3-bolt design internal disc mufflers
- 11318 Open end cap for 3-bolt design internal disc mufflers



Replacement Parts and Accessories for SuperTrapp 4" Megaphone External Disc Series Systems

- 11150 Exhaust shield/deflector. May be installed over the discs to provide 120° of protection from exhaust soot
- 11151 Diffuser discs (pack of six)
- 11154 Custom-machined aluminum end cap
- 11155 Stock replacement stainless steel end cap
- 11156 Stainless steel open end cap. Used for improved performance and louder exhaust note
- 11152 Screw kit (pack of six) stock replacement stainless steel screws which permit the use of up to 20 discs
- 11153 Screw kit (pack of six) stainless steel screws which permit the use of up to 34 discs, but not fewer than 15

EXHAUST

- APPAREL
- SEATS & BAGS
- FOOT CONTROLS
- HAND CONTROLS
- LIGHTING
- ELECTRICAL

EXHAUST

- INTAKE
- ENGINE
- GASKETS
- TRANSMISSION & CLUTCH
- DRIVELINE
- WHEELS TIRES & BRAKES
- CHASSIS
- SHEETMETAL
- INSTRUMENTS & GAUGES
- GENERAL
- CROSS REFERENCE

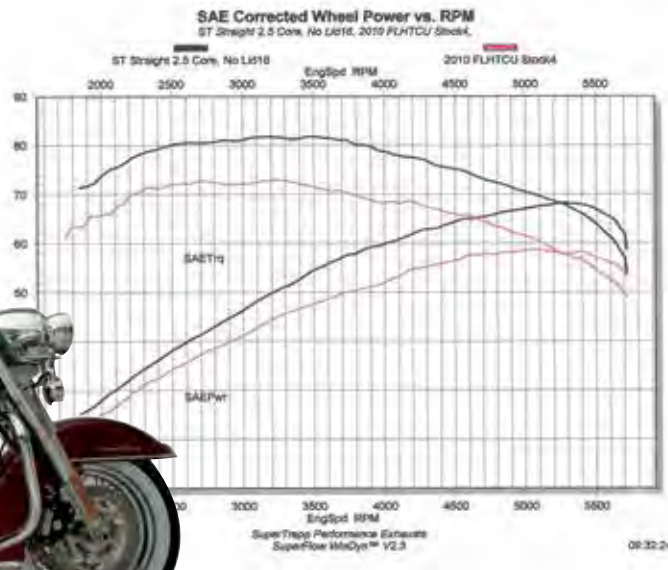

Supertrapp Stout 4" Slip-On Mufflers

Available for 95-13 FLH / FLT models. Non-Tunable, massive 4" chromed body Slip-Ons. Newly developed core. Streamlined, internal Tapered, Billet Aluminum End Cap comes pre-installed. The recessed fasteners in the End Caps are a sign of the true craftsmanship that went into the design of these pipes. Newly shaped inlets flow better into the OEM head pipe.

Supertrapp Stout 4" Slip-Ons

- 2.4dB louder than stock @ 95.6dB
- Newly-developed tapered core on 10-Up models
- Heavy, broad spread power curve from idle
- 9.3 (16%) hp & 10.5 (14%) torque gain over stock
- SAE-J2825 sound compliant
- Compatible w/ SuperTrapp True Duals and OEM headers.

- 664612** FLH, FLT 10-Up
- 664613** FLH, FLT 95-09
- 664618** FLH, FLT black 10-Up
- 664617** FLH, FLT black 95-09



SuperTrapp "Phantom Pipes" for Touring models by Paul Yaffe Originals

This is the loud and stylish, black ceramic pipe your bagger has been begging for. Decorative billet end tip engraved with domino dots gives it a look all its own. Includes 4-piece stylized, chrome heat shields to keep you worry-free about discoloring. Based on the original Phantom pipe but, with a bagger flare. You know you want it.

Fits Touring Models from 86-Up*

- 664599** Black with chrome heat shields 86-09
- 664598** Black with chrome heat shields 10-13

* Includes O2 sensor port



EXHAUST



*Mufflers shown for reference only



664623



664616

Supertrapp True Dual Headers

SuperTrapp True Duals feature 2.25" full length Chrome or Black heat shields for 09-13 models to ensure a cool ride for both the rider and the passenger. For 85 - 08 models, they feature 2" full length Chrome or Black heat shields. They are compatible with numerous SuperTrapp and Kerker Slip-Ons such as: SuperTrapp and Kerker Stout 4" Slip-Ons which are both available in chrome or black, SE Series, Kerker Series and Mean Mothers Slip-Ons.

- 664616 Black true dual headers, Touring models 10-13
- 664615 Black true dual headers, Touring models 09
- 664623 Chrome true dual headers, Touring models 10-13
- 664622 Chrome true dual headers, Touring models 09



664025



664028

SuperTrapp 3.5" Chrome & Billet End caps for Low Roller Exhaust and SE Series Slip-ons.

Billet End Caps. Sold Each.

- 664025 Tapered Slash Cut Billet - Chrome
- 664028 Yaffe Afterburner - Black



Optional End Caps

664023



664018



664024



664026



664019



664021



SuperTrapp 3.5" Chrome & Billet End caps for Low Roller Exhaust and SE Series Slip-ons.

Chrome End Caps. Sold Each.

- 664018 Tapered chrome
- 664019 Slash Cut chrome
- 664023 Turndown / Turnout 90 degree rotatable
- 664024 Fishtails
- 664026 Java Jugs

Billet End Caps. Sold Each.

- 664021 Grooved Billet - Chrome



SuperTrapp SE Series 3,5" Slip-Ons for Touring Models

The King of rideable and usable torque and champion of numerous magazine shootouts. The best-selling and most widely used aftermarket exhaust providing a 10-12% horsepower gain. Steel, chrome-plated shells, mild Steel core and double wall construction prevents bluing. Race proven mechanical baffle increases torque and horsepower and is less than 3dB louder than stock. Internal baffle heatshield eliminates body bluing for years of riding in worry-free style. All chrome, billet and Yaffe end caps are compatible with SE Series Slip-Ons. Select models of SE Series Slip-Ons are available in SuperPak Performance Kits.

- 664022 Fits FLH/FLT models 95-09*.Pair.

*Does not include end caps. Uses SE series end caps

EXHAUST



664000



SuperTrapp V5 2-into-1 Slip-On Exhaust System for V-Rod Models

The ultimate pipe for your V-Rod. SuperTrapp's external disc technology is incorporated into the company's first ever 5" pipe. Provides a significant horsepower increase and a deep throaty exhaust note and uses your stock headpipe. It not only looks better but also weighs a whopping 21 lbs. less than the stock system. The tunable disc system allows the rider to add discs to increase the exhaust sound and top end power; by removing discs the low-end torque increases and the exhaust sound is also decreased. Features a triple chrome-plated mid pipe, heat shields and canister, stainless steel core and polished billet end cap.

664605 Fits all 07-10 VRSCX/AW/AWA models

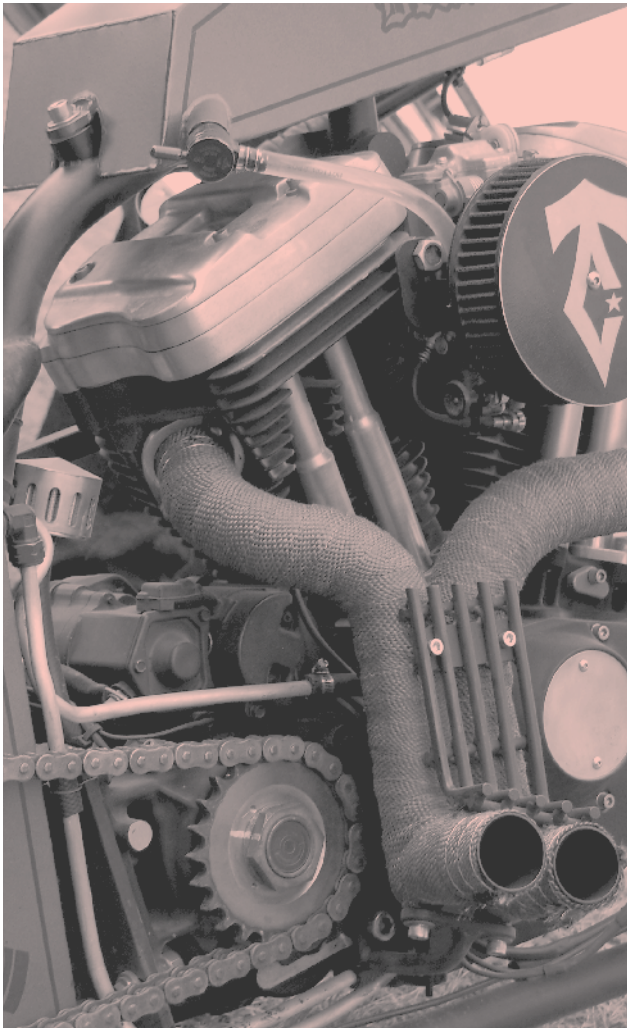

SuperTrapp 'X-Pipes' by Paul Yaffe Originals

- Hot shotgun styled pipes designed by Paul Yaffe for the SuperTrapp 'Road Legends' series.
- Available in a chrome-plated, ceramic black or silver coated finish.
- All pipes include heatshields.

Fits all Dyna Models from 91-14

664061 Chrome-plated finish for 06-14 models*

Note: *Includes O2 sensor port



SuperTrapp 4" Universal Muffler in Black

High temperature coated black steel body with stainless steel core. 18.5" length. For those who want to build their own exhaust. Available in 1.75" inlet diameters.

664040 1.75" inlet



SuperTrapp 'Mean Mothers II' Drag Pipes

The latest version of the Mean Mothers drag pipes have been revised and re-designed. They will have the same big look and booming sound as always but we have added a few goodies. A new mounting design makes them easier to install and the removable baffles come pre-installed. The heat shields are still preinstalled but now they are replaceable. Redesigned optional end tips and new protective packaging round out the added features Full double-walled chrome drag pipes with baffles. Stock end caps included. Optional end cap styles sold separately.

696235 Mean Mothers II, standard for Softail FXST/FLST models 84-14

696237 Mean Mothers II, short for Softail FXST/FLST models 84-14

696239 Mean Mothers II, long for Softail FXST/FLST models 84-14

696241 Mean Mothers II, staggered for FXD models 06-11 without O2 sensor threads

696242 End cap slash cut for Mean Mothers II systems

696243 End cap turn down/out for Mean Mothers II systems

696244 End cap rolled edge for Mean Mothers II systems

APPAREL

SEATS & BAGS

FOOT CONTROLS

HAND CONTROLS

LIGHTING

ELECTRICAL

EXHAUST

INTAKE

ENGINE

GASKETS

TRANSMISSION & CLUTCH

DRIVELINE

WHEELS TIRES & BRAKES

CHASSIS

SHEETMETAL

INSTRUMENTS & GAUGES

GENERAL

CROSS REFERENCE

EXHAUST



664031



664032



Supertrapp SE Series Endcaps

These are Supertrapps latest creation. The Holy Moly endcaps. Available in your choice of black or chrome finish. Fit SE Series or Kerker and Mean mothers exhausts. Sold each.

664031 Chrome

664032 Black



11868

SuperTrapp TrappCaps

A beautiful addition to any 4" external disc SuperTrapp muffler. Machined from billet aluminum and hand-polished to a mirror finish. Can be run open for maximum sound and top end power, or closed for improved low end torque and quieter operation. Sold each.

11868 'Cone'

6



11194

11210

11198



SuperTrapp 3" Internal Disc Series End Caps

Replacement optional end caps for all 3 1/2" Internal Disc mufflers. Sold each.

11194 Slash-cut style

11210 Turn-down style

11198 Turn-out style



SuperTrapp 4" 'Racing Series' Universal Aluminum Mufflers

Round aluminum body with satin finish is ideal for those who choose to make their own custom racing systems. Available in 1 3/4" or 2" inlet diameters. Includes a stainless steel header clamp, a pair of weld-on mounting brackets, and diffuser discs. Sold each. 12" length

84789 1 3/4"-inlet



664017

Kerker 2-Into-1 'SuperMegs' Exhaust Systems

Dyno proven performance and awesome style set these pipes apart from the crowd. Kerker's unique bracket mounts the exhaust system to the transmission eliminating the flexing and potential cracking of the headpipe/muffler assembly. The systems are available either triple chrome-plated or black ceramic coated mild steel finish. Included three piece heat shields have a unique design that provides full coverage for the front and rear headpipes and collector.

664608 For Touring models 09, Chrome*

664609 For Touring models 09, Black*

664050 For Touring models from 07-08, Black*

664001 For Touring models 85-06, Chrome

* Includes O2 sensor port

EXHAUST



664023



664024



664018



Kerker Chrome End Caps

Matched to Kerker exhaust systems. Choose a custom look that can be easily changed by simply switching end caps. Sold each.

- 664023** Turndown / Turnout 90 degree rotatable
- 664024** Fishtails
- 664018** Tapered chrome



AVAILABLE IN BLACK

Kerker 'Stouts' 4" Slip-On Touring Mufflers

- 5dB louder than stock @ 97dB
- Utilizes traditional core for all models
- Bold, strong, higher spread of power w/ more mid range RPM up through redline
- 9.6 (17%) hp & 9 (12%) torque gain over stock
- Classic Kerker, deep, heavy rumble sound
- Compatible w/ SuperTrapp True Duals or OEM headers

- 664610** Kerker Stouts for 10-14 Touring models
- 664611** Kerker Stouts for 95-09 Touring models
- 664620** Kerker Stouts black for 10-14 Touring models
- 664619** Kerker Stouts black for 95-09 Touring models



11740 with
664024 tips



11740 with
664023 tips



11741 with
664018 tips

Kerker Chrome Slip-On Touring Mufflers

Sold in pairs for Touring and FLSTS models. Sold without tips, see available styles above.

- 11741** For Touring models 95-09
- 11740** For Touring Models 85-94
- 11745** For Touring models 95-09 (tuned for Mikuni Pass-a-Truck Kit)
- 11742** For FLSTS models 97-07
- 11743** For FLSTS models 97-08 (tuned for Mikuni Pass-a-Truck Kit)
- 664069** For 10-Up Touring models

Replacement Cores for Kerker Systems

- 11342** Replacement fiberglass-wrapped baffle core for all slip-on Touring mufflers (except FLSTS)
- 664007** Replacement baffle for all Mikuni Pass-a-Truck mufflers

- APPAREL
- SEATS & BAGS
- FOOT CONTROLS
- HAND CONTROLS
- LIGHTING
- ELECTRICAL
- EXHAUST
- INTAKE
- ENGINE
- GASKETS
- TRANSMISSION & CLUTCH
- DRIVELINE
- WHEELS TIRES & BRAKES
- CHASSIS
- SHEETMETAL
- INSTRUMENTS & GAUGES
- GENERAL
- CROSS REFERENCE

EXHAUST



631041

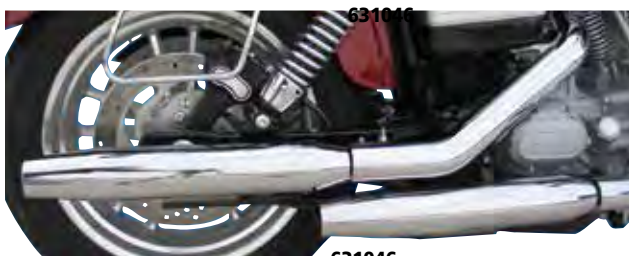

631046

3" HP-Plus Slip-On Mufflers by Khrome Werks

High Performance mufflers for all current HD models. Khrome Werks HP-Plus patented steel construction baffle, which now features more high temperature fiberglass packing, provides significant gains in both horsepower and torque and exhibits a distinctive, deep throaty sound. All models retain factory crossover features and utilize factory brackets, clamps, gaskets, and mounts. Made in the USA, and available with slash cut or tapered ends. Sold in sets.

For all Dyna Glide Models 95-15, FXDWG 95-05 (except FXDF)

631041 Slash Cut

631046 Tapered

For all Sportster Models with Crossover 04-13

631040 Slant Down

631045 Tapered

Note: Sportster models feature a 'Slash Down' style

For 00-06 Softail Models with Crossover and Twin Cam 88B Engines (except Deuce, Fat Boy and FLSTN Softail Deluxe Models)

631042 Slash Cut

For 07-15 Softail models with Twin Cam 96B Engines (except Deuce, Fat Boy and FLSTN Softail Deluxe Models)

631050 Slash Cut

631053 Tapered

For 07-15 Fat Boy and Deuce Models with Twin Cam 96B Engines

631051 Slash Cut

631054 Tapered

For 05-06 FLSTN Softail Deluxe with Twin Cam 88B Engines

631044 Slash Cut

631055 Tapered

For 07-14 FLSTN Softail Deluxe and FLSTSB & FLS with Twin Cam 96B Engines

631052 Slash Cut

631055 Tapered

For 08-15 FXDF and 10-15 FXDWG Models

683408 3" HP-Plus slash cut muffler 08-Up Dyna



Khrome Werks HP-Plus Drag Pipe Baffles

The ultimate drag pipe baffles. They feature all-steel construction and dampen the sound without impeding the flow. They're designed on the same principles as the baffles found in the popular 'AR II' exhaust systems, and will fit any 1 3/4" or 2" drag pipes.

31481 For 1 3/4" drag pipes, pair

31574 For 1 3/4" drag pipes, each

31482 HP-Plus baffles for 2" pipes (sold in pairs)

31575 HP-Plus baffle for 2" pipes (sold each)

631804 For 2 1/4" drag pipes, pair

631803 For 2 1/4" drag pipes, each



Khrome Werks AR Power Cones

Drop a set of Power Cones into the headpipes of most stock and aftermarket 1 3/4" exhaust systems on Evolution and Twin Cam engines and reap the benefits of the patented 'Anti-Reversionary' design found in Python, AR and ARII high-performance exhausts. They're made of stainless steel. Sold in pairs.

31723 Khrome Werks ar power cones

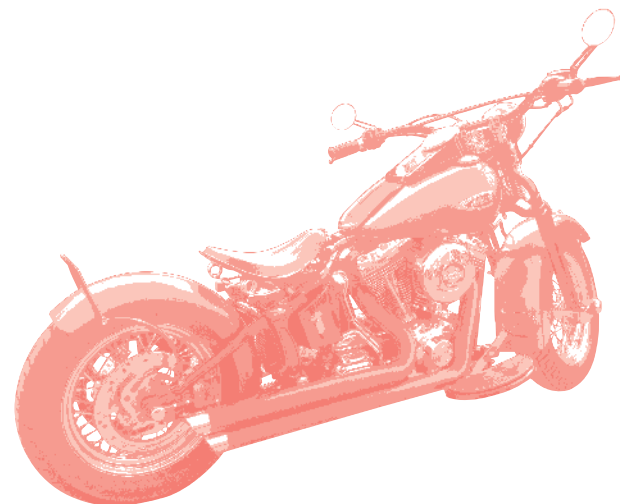

EXHAUST



APPAREL

SEATS & BAGS

FOOT CONTROLS

HAND CONTROLS

LIGHTING

ELECTRICAL

EXHAUST

INTAKE

ENGINE

GASKETS

TRANSMISSION & CLUTCH

DRIVELINE

WHEELS
TIRES &
BRAKES

CHASSIS

SHEETMETAL

INSTRUMENTS
& GAUGES

GENERAL

CROSS
REFERENCE



652115



652114



652117

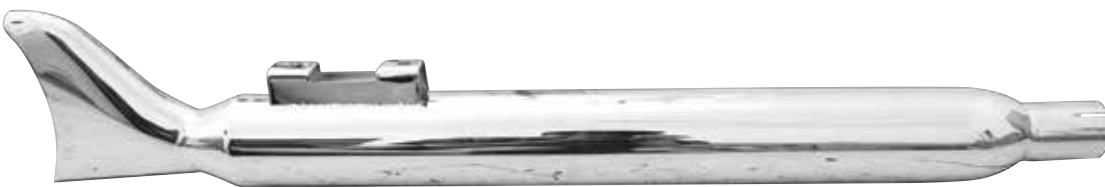

652116

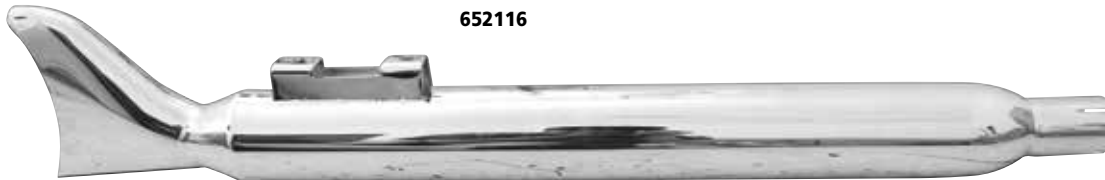

Slip-on Mufflers by DNA

Unbeatable quality and sound at an affordable price. Available in a show chrome or rich black finish, these megaphone or fishtail mufflers will improve the look and sound of your ride immensely. Fit Touring models from 95-Up. Sold in pairs.

652114 Megaphone slip-on mufflers chrome

652115 Megaphone slip-on mufflers black

652116 Fishtail slip-on mufflers chrome

652117 Fishtail slip-on mufflers black

EXHAUST



NEW



649625

Yaffe Buzzsaw Exhaust Systems by Paughco

Designed by Paul Yaffe made by Paughco in the USA. These custom style drag pipe exhaust systems features a 1-3/4" head pipes and 2-1/4" partial 3/4 length heat shields giving it that special Yaffe design. All pipes include 12mm and 18mm O2 sensor bungs and block off plugs and necessary mounting brackets with hardware. Available in chrome finish with chrome heat shields or black satin high temp powder paint with black heat shields.

- 649625 Chrome Softtail models 86-Up
- 649626 Black Softtail models 86-Up
- 649627 Chrome Touring models 93-Up
- 649628 Black Touring models 93-Up

6



649626



NEW



649600

649604

King's Custom Cycle 2 into 1 Collector Style Exhaust Systems by Paughco

Designed by King's Custom Cycle made by Paughco in the USA. These 2 into 1 collector style exhaust systems features a unique 6 bolt tail pipe piece with a double barrel style design tip angled that can be rotated to almost any direction. Includes 1-3/4" head pipes and 2-1/4" full length heat shields with 3" diameter collector. Twin Cam models include 12mm and 18mm O2 sensor bungs and block off plugs. Available in chrome finish with chrome heat shields or black satin high temp powder paint with black heat shields.

Touring Models

- 649600 Chrome Touring models 99-Up
- 649601 Black Touring models 99-Up
- 649602 Chrome Touring models 93-98
- 649603 Black Touring models 93-98

Softtail Models

- 649604 Chrome Softtail models 00-Up
- 649605 Black Softtail models 00-Up
- 649606 Chrome Softtail models 86-99
- 649607 Black Softtail models 86-99

EXHAUST

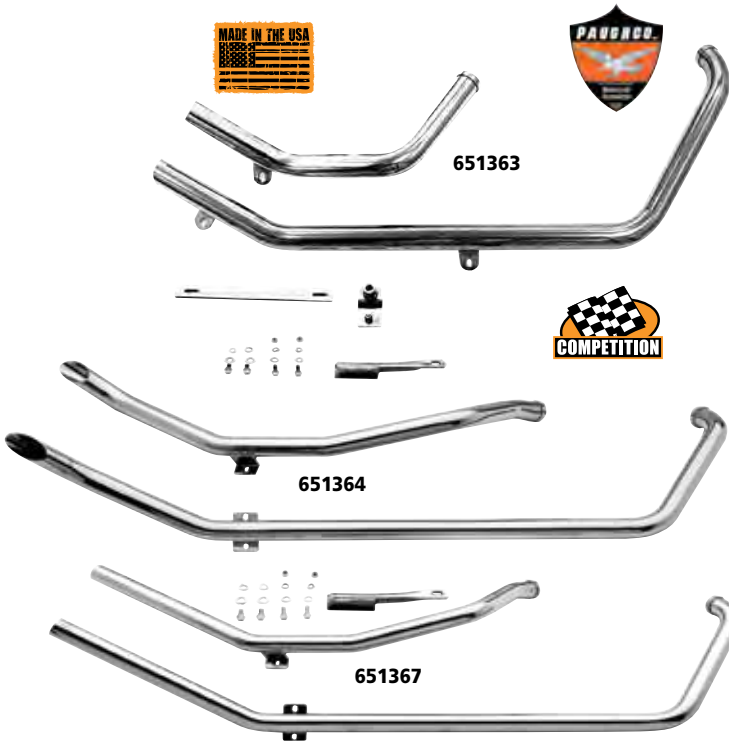

Upsweep Drag Pipes for Evolution Softails by Paughco

Want that classic upswept look for your Evo chopper? Look no further! You have three styles to choose from. Brackets included. Fit 86-99 Softails.

- 651364** Upsweep goose drags
- 651366** Upsweep slash drags
- 651367** Upsweep straight drags
- 651363** Unsweep headers only

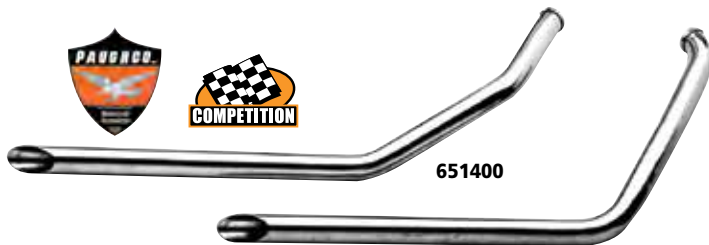

Drag Pipes for Dynas by Paughco

40" long drag pipes for Evolution and Twin Cam Dynas. Made in the USA.

- 651400** 91-06 Dyna drag pipes
- 651401** 07-13 Dyna drag pipes

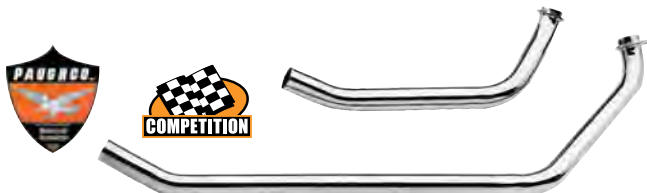

Paughco Upsweep Headers for Shovelheads

1 3/4"-diameter upsweep header set for Shovel-heads in swingarm frames. Will work with FXE battery boxes, and mounting brackets are included. Use with our exhaust extensions or mufflers which are sold separately.

- 632285** Upsweep header set for Shovelhead models from 70-84

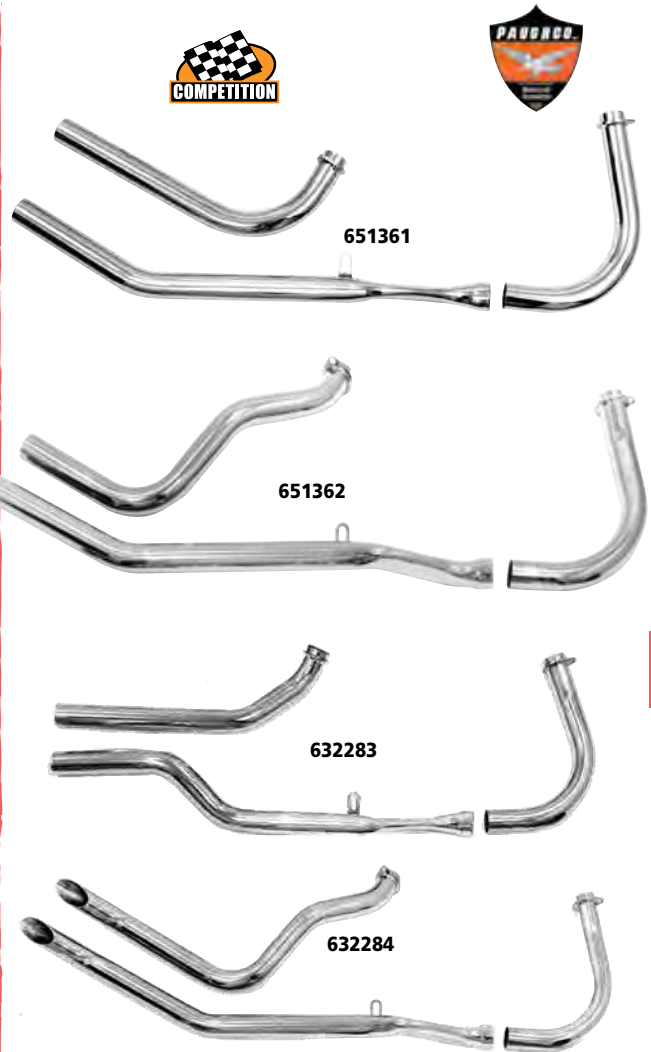

Paughco Pipes for Shovelheads

1 3/4"-diameter, 3-piece 'S' style side-by-side headers, upswept headers, upswept slash pipes and a gooseneck pipe set for all Shovelheads in rigid frames with kickstart only from 66-84. The exhaust extensions for the header sets are sold separately. Some pipes may require the fabrication or purchase of separate brackets.

- 632283** 3-piece side by side headers
- 651362** 3-piece upsweep headers
- 651361** 3-piece upsweep headers
- 632284** 3-piece gooseneck pipe set (hardware included)
- 651396** 2-piece gooseneck pipe set 70-84
- 651368** 3-piece slash cut pipe set
- 651424** Hanger bracket for 651396

- APPAREL
- SEATS & BAGS
- FOOT CONTROLS
- HAND CONTROLS
- LIGHTING
- ELECTRICAL
- EXHAUST**
- INTAKE
- ENGINE
- GASKETS
- TRANSMISSION & CLUTCH
- DRIVELINE
- WHEELS, TIRES & SPOCKETS
- CHROME
- SHEETMETAL
- INSTRUMENTS & GAUGES
- GENERAL
- CROSS REFERENCE

EXHAUST



651390



651391



651392

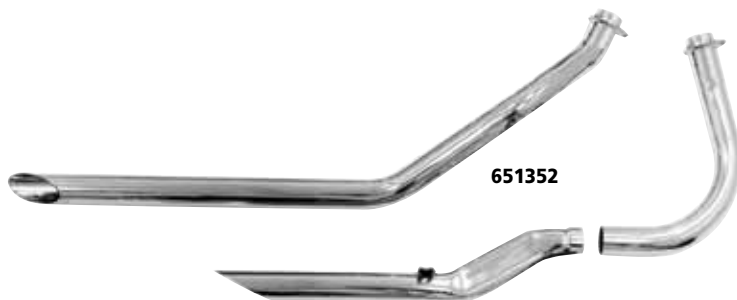

651352

Shotgun and Staggered Dual Drag Pipes for Shovels by Paughco

Staggered drag pipes are 1 3/4" diameter and 34" or 40" long with a rear pipe "over transmission" version available. Shotgun drags are 40" long. Fit Shovels with swingarm frames (non FLH).

- 651389** 34" Staggered drag pipes 66-69
- 651390** 40" Staggered drag pipes 66-69
- 651391** 40" 2-piece Over tranny drag pipes 66-69
- 651352** 40" 3-piece Over tranny drag pipes 66-69
- 651392** 40" Shotgun drag pipes 66-69
- 651393** 40" Shotgun drag pipes RIGID 66-69
- 651398** 40" Shotgun drag pipes RIGID 70-84

Note: Requires custom bracket for installation



651406



651407



651408

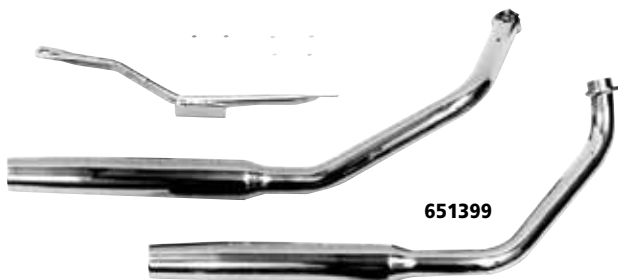

651399

Exhaust Systems for Shovels by Paughco

Choose from four different styles of 2 into 2 exhaust systems for your Shovel.

- 651406** 34" Drags for 70-84 FLH
- 651407** 34" Goose drags for 70-84 FLH
- 651408** 38" Slash muffler system for 70-84 FLH
- 651388** 38" Tapered muffler system for 66-69 FX
- 651399** 38" Tapered muffler system for 70-84 FX

EXHAUST



651394



651365

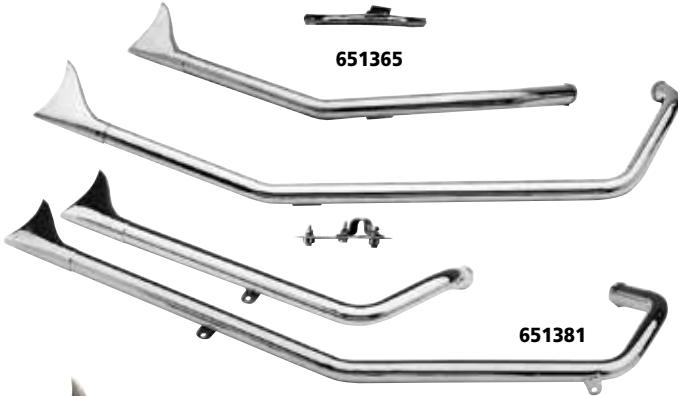

651381



651371



Upsweep Fishtail Pipes by Paughco

These pipes never go out of style! Classic upswept fishtails go with any chopper. Include brackets and hardware where applicable.

- 651365** Fits 86-99 Softtail models
- 651395** Fits 00-06 Softtail models
- 651394** Fits 00-06 Softtail models, head pipes only
- 651381** Fits 57-85 XL models with rigid frames
- 651371** Fits 86-03 XL models with rigid frames



NEEDS CUSTOM BRACKET FOR INSTALLATION



Slashed Shotgun Drag Pipes for Shovelheads 70-84 by Paughco

This bitchin' set of 1 3/4" Shotgun style drag pipes are 40" long, feature slash cut ends and T-bolt slider channels for hidden mounting. For use on 70-84 frames with electric start & wrap-around oil tank. Made in USA by the gang at Paughco.

632901 Slashed Shotgun Drag Pipes for Shovelheads 70-84



NEEDS CUSTOM BRACKET FOR INSTALLATION



Drag Pipes for Generator Shovels 66-69 by Paughco

Here's a great lookin' set of 1 3/4" drag pipes with rear pipe in front of tranny for use in swingarm frames. Will also work with rigid frames if the mechanical brake crossover tube has been removed. Look great on frames with extended front ends! Pipes are 40" long, and feature T-bolt slider channels for hidden mounting. Made in USA by the gang at Paughco.

632903 Drag Pipes for Generator Shovels 66-69

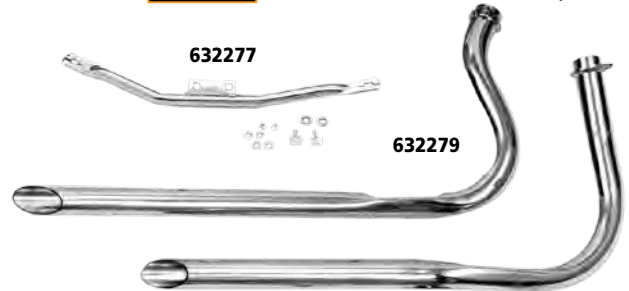

632277

632279

Staggered Duals for Shovelheads by Paughco

40" long 1 3/4" staggered dual exhaust drag pipe system for 66-69 swingarm Shovelhead applications. Work with kick or electric start, and tucks up nicely under floorboards so they won't drag on right hand turns. Also ideal for use with Shovelhead top/Panhead bottom engines in swingarm frames. Slider channels on back of pipes for a clean look. Use hanger bracket #632277. Made in USA by Paughco.

632279 1 3/4" Staggered duals for shovels in swingarm frames

632277 Hanger bracket

APPAREL

SEATS & BAGS

FOOT CONTROLS

HAND CONTROLS

LIGHTING

ELECTRICAL

EXHAUST

INTAKE

ENGINE

GASKETS

TRANSMISSION & CLUTCH

DRIVELINE

WHEELS TIRES & BRAKES

CHASSIS

SHEETMETAL

INSTRUMENTS & GAUGES

GENERAL

CROSS REFERENCE

EXHAUST



632276



Staggered Duals for 58-64 Panheads

40" long 1 3/4" staggered dual exhaust drag pipe system for 58-64 swingarm Panhead applications. Work with kick or electric start, and tucks up nicely under floorboards so they won't drag on right hand turns. Slider channels on back of pipes for a clean look. Use hanger bracket #632277. Made in USA by Paughco.

632276 1 3/4" Staggered duals for swingarm 58-64 Pans.

632277 Hanger bracket



NEEDS CUSTOM BRACKET FOR INSTALLATION



Drag Pipes For Panheads 48-65 by Paughco

These are a pair 1 3/4" staggered dual Drag Pipes that fit Panheads 48-65 with rigid frames & mechanical brakes, as well as swing arm frames. The pipes are 40" long and feature T-bolt slider channels for hidden mounting. Made in USA by Ron & the gang at Paughco.

632900 40" Drag Pipes for Panheads 48-65

6



632278



Side by Side Header Pipes for Panheads

1 3/4" side-by-side 3-piece "S" style header pipe set for 48-64 Panhead engines in rigid frames with kick start only. Exhaust extensions sold separately. Made in USA by Paughco.

632278 Side by side header pipes for kickstart Panheads in rigid frame



651358

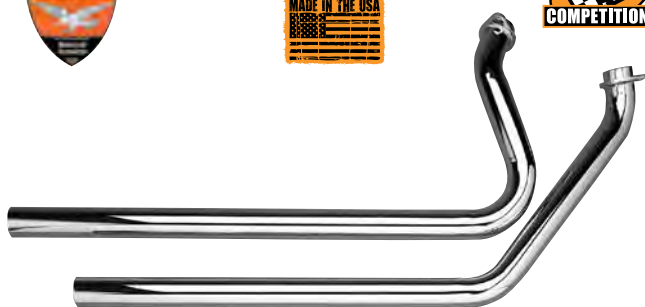

Drag Pipes for 4-Speed FL Models with Kick or Electric Start

Designed to clear factory fiberglass saddlebags or rear highway bars, these 1 3/4" drag pipes are available in straight cut version to fit 4-speed FL's with kick or electric start. The rear pipe is an under-the-transmission style for a tucked in look. Each set includes a chrome mounting bracket. Made in USA by the Paughco crew.

11263 1 3/4" Straight-Cut Drag pipes



651360



Upsweep Drag Pipes for Panheads by Paughco

These pipes fit on any Panhead motor in a rigid frame.

Available in three styles.

651358 Upswept Goose drags 48-57

651359 Upswept slash pipes 48-57

651360 Upswept straight pipes 48-57

EXHAUST



Staggered Dual Drag Pipes for Sportsters by Paughco

These drag pipes are available for late Evo Sportsters in slash or "goose cut" versions. Include mounting bracket and hardware.

Slash Cut

651378 Fits 04-13 XL with O2 bungs

Goose Cut

651377 Fits 04-06 XL

651379 Fits 07-13 XL with O2 bungs

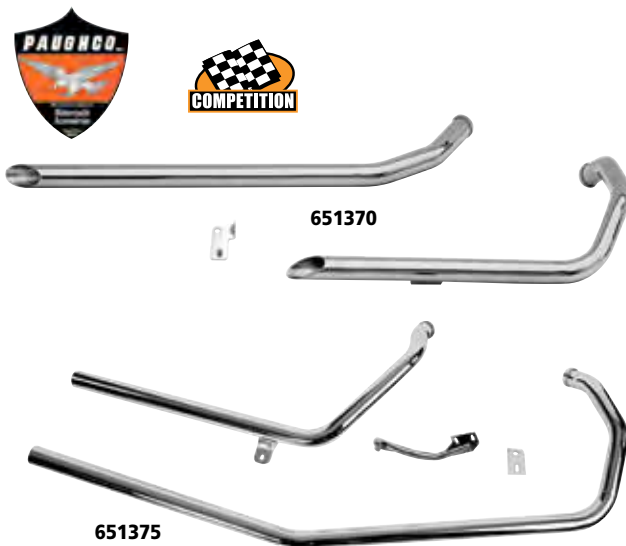

Dragpipes for Sportsters by Paughco

Choose from shotgun or upsweep drag pipes for your Sportster. Rigid and swingarm versions available.

651370 Shotgun drags rigid XL 86-03

651385 Shotgun drags 34" XL 57-85, rigid

651386 Shotgun drags 40" XL 57-85, rigid

651374 Upsweep drags rigid XL 86-03

651375 Upsweep drags swingarm XL 86-03

651382 Upsweep drags rigid XL 57-85



Paughco Upswept Pipes for Sportster Models

1 3/4"-diameter upsweep pipe sets in gooseneck and slash-cut styles to fit rigid or swingarm Sportster models from 57-03.

632286 Gooseneck upsweep pipe set for rigid frame applications from 57-85 (except 79 engines). Mounting bracket is included

632287 Gooseneck upsweep pipe set for Evolution Sportster engines in rigid and swingarm frames (swingarm mounting bracket included. Rigid frames require additional purchase of CC #632288)

632289 Slash-cut upsweep pipe set for rigid frame applications from 57-85 (except 79 engines). Mounting bracket is included

632290 Slash cut upsweep pipe set for Evolution Sportster engines in rigid and swingarm frames (swingarm mounting bracket included. Rigid frames require additional purchase of CC #632288)

632288 Rigid frame mounting bracket for CC #'s 632287, 632290



Drag Pipes for 79 Sportsters by Paughco

If you own a 79 Sportster, you've already found out that for that one year only, you need pipes with a different configuration... lucky you! We haven't forgotten about you though Bro, and here's a sweet set of Drag Pipes just for your '79 XL! These bitchin' 1 3/4" pipes are 40" long, slash cut, and feature T-bolt slider channels for hidden mounting. Made in USA by the gang at Paughco.

632902 Drag Pipes for 79 Sportsters



APPAREL

SEATS & BAGS

FOOT CONTROLS

HAND CONTROLS

LIGHTING

ELECTRICAL

EXHAUST

INTAKE

ENGINE

GASKETS

TRANSMISSION & CLUTCH

DRIVELINE

HEELS, RES & BRAKES

CHASSIS

SHEETMETAL

INSTRUMENTS & GAUGES

GENERAL

CROSS REFERENCE

EXHAUST



651409



651411



651412



651414



651420

6

Crossover Dual Exhaust Headers by Paughco

These 1 3/4" headers work great if you are replacing your OEM dual crossover or converting your bike to dual exhausts. Choose the mufflers to match the style you want.

- 651409** 3-piece C/O duals 70-84 FL
- 651410** 4-piece C/O duals 66-69 FL
- 651411** 3-piece C/O duals 85-94 FLT
- 651429** Front heatshield for 651411 and 651416 thru 651419
- 651430** Rear heatshield 85-94 FLT



651416



651417

Independent Dual Headers for Touring models by Paughco

Looking for a custom true dual exhaust for your Touring model? Here it is, just choose the headers to fit your bike and the mufflers or extensions you like.

- 651416** Dual headers for 85-94 FLT
- 651417** Dual headers for 95-98 FLH/FLT
- 651418** Dual headers for 99-06 FLH/FLT
- 651419** Dual headers for 07-09 FLH/FLT

Optional Accessories

- 651372** Rear heatshield for 651416 and 651417
- 651429** Front heatshield for 651411 and 651416 thru 651419

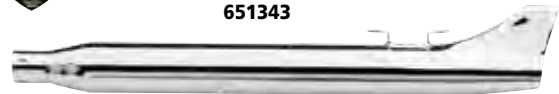

651343



632905

"Rocket" Style Muffler by Paughco

These old school style "Rocket" mufflers look great on baggers or retro bobbers! The muffler is 28" long, 3" in Diameter and attaches to 1 3/4" exhausts. A top quality muffler with a nice throaty sound, and brilliantly chromed! Sold each. Exhaust bracket/clamp sold separately. Made in USA by the gang at Paughco.

- 632905** "Rocket" Style Muffler
- 651342** "Rocket" style muffler 31 inches universal
- 651343** "Rocket" style muffler 31 inches 95-09 FLT

Independent Dual Headers for Pans and Shovels by Paughco

True duals work performance wonders on new bikes and now you can have the same benefits for your old scooter too. And they sound great too! Add your choice of mufflers and go.

- 651412** Dual headers 48-65 rigid panheads
- 651415** Dual headers 48-65 swingarm panheads
- 651414** Dual headers 66-69 swingarm shovels
- 651413** Dual headers 70-84 FL shovels
- 651420** Dual headers 80-83 FLT five speed shovels

Optional Accessories

- 651431** Rear heatshield for 651420
- 651429** Front heatshield for 651411 and 651416 thru 651419

EXHAUST

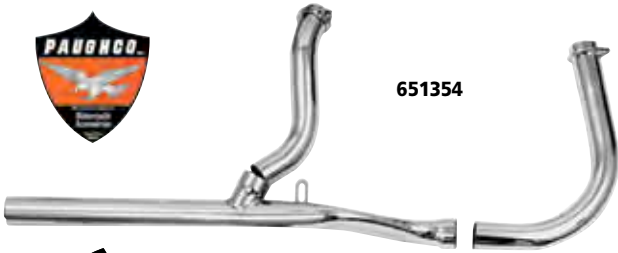

651354



651404



651384



651428

2 into 1 Headpipes by Paughco

These head pipes are 1 3/4" diameter and will accept most universal mufflers in this section. They are 2 to 3 piece sets depending on application.

- 651350 58-65 Big Twin 2in1 hydraulic brake
- 651351 58-65 Big Twin 2in1 mechanical brake
- 651354 66-69 Big Twin rigid frame 2in1
- 651402 70-84 FL models 2in1
- 651404 80-83 5-Speed FLT models 2in1
- 651383 86-03 Sportster 2in1
- 651384 57-85 Sportster 2in1

Optional Accessories

- 651428 Heatshield for 651351



"Trim Tail" Style Muffler by Paughco

Here's Paughco's version of the old style "Trimtail" mufflers that are great for restoration, or on that retro ride you're putting together! The muffler is 28" long, 2 1/2" in Diameter and attaches to 1 3/4" exhausts. A top quality muffler with a nice deep sound, and brilliantly chrome plated! Sold each. Exhaust bracket/clamp sold separately. Made in USA by the gang at Paughco.

- 632904 "Trim Tail" Style Muffler



Clamp-on Fishtail Tip by Paughco

Universal fishtail tip slips over any 1 3/4" diameter headpipe.

- 651334 Fishtail tip



632269



632270



632271

Custom 31in. Exhaust Extensions by Paughco

Chrome plated exhaust extensions for 1 3/4" dia. pipes, available in fishtail, slash cut or gooseneck versions. Made in USA by Paughco. Sold each.

- 632269 31" Fishtail (bent up) extension for 1 3/4" dia. pipes
- 632270 31" Slash cut extension for 1 3/4" dia. pipes
- 632271 31" Gooseneck extension for 1 3/4" dia. pipes

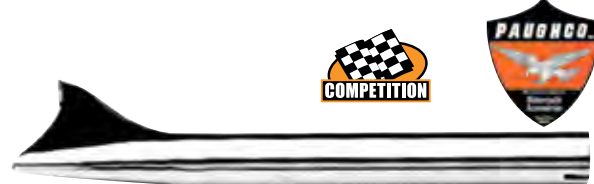

Straight 18" Fishtail by Paughco

Universal straight un-baffled fishtail pipe slips over any 1 3/4" diameter headpipe. Eighteen inch overall length. Sold each.

- 651333 Fishtail pipe



Classic Fishtail Muffler

Show-chrome muffler with an antique-style tip. This clean, bracketless muffler allows left or right side mounting and has a 1 3/4"-inlet, and is 35"-long. Sold each.

- 11419 Fishtail muffler

APPAREL

SEATS & BAGS

FOOT CONTROLS

HAND CONTROLS

LIGHTING

ELECTRICAL

EXHAUST

INTAKE

ENGINE

GASKETS

TRANSMISSION & CLUTCH

DRIVELINE

WHEELS TIRES & BRAKES

CHASSIS

SHEETMETAL

INSTRUMENTS & GAUGES

GENERAL

CROSS REFERENCE

EXHAUST



651335



651340



651348



"Fishtail" Style Muffler by Paughco

The muffler is 22 1/2" long, 1 7/8" in Diameter and attaches to 1 3/4" exhausts. A top quality muffler with a nice deep sound, and brilliantly chrome plated! Sold each. Exhaust bracket/clamp sold separately. A second version with a slider for installation on the right side is also available and a 2 1/2" diameter, 30" long version for 80-84 FLT models, a 3" diameter, 29" version for 85-94 Touring models and a 3" diameter, 31" version for 95-13 Touring models. Sold each. Made in USA by the gang at Paughco.

- 651335 Fishtail style muffler
- 651336 Slider fishtail muffler
- 651340 80-84 FLT muffler (left)
- 651341 80-84 FLT muffler (right)
- 651347 85-94 Touring
- 651348 95-13 Touring



Universal Turnout or Turndown Muffler by Paughco

Turnout muffler that connects to any 1 3/4" headpipe. 3" diameter, all steel internal baffles, can be rotated and used as a turndown muffler. Sold each.

- 651344 Turndown muffler



Vintage Slip-On Muffler

This chrome reproduction of the 58-65 Panhead 'Shorty' muffler works with single or dual (crossover) 1 3/4" diameter header pipes and most stock brackets. Measures 3 1/4"-diameter x 25 1/2" long. Sold each.

- 280925 Slip on muffler



651338



651339



Universal Tapered Mufflers by Paughco

Available in two versions. A 3 inch diameter, 30 inch long muffler or a 2 1/2 inch with 22 inches of length. Both fit over 1 3/4 inch head pipes. Sold each.

- 651338 Muffler 22 inches
- 651339 Muffler 30 inches



FL-Style Fishtail Mufflers

Show-chrome replicas of the mufflers found on 58-66 FL models. These clean, bracketless mufflers permit left or right-side mounting and have a 1 3/4"-inlet. Available in two lengths. Sold each.

- 11420 28"-long muffler (repl. OEM 65244-62TA)
- 11421 33"-long muffler (repl. OEM 65258-88T)
- 11214 3 1/4" stainless steel muffler clamp (repl. OEM 65293-58)



Universal Shorty Muffler

A versatile, universal 11 3/4"-long muffler with one 1 3/4" and one 1 1/2" opening. By simply reversing the muffler, it can work on either 1 3/4" or 1 1/2" exhaust systems. The shorty muffler comes complete with a welded-on stud, hardware and flat strap for mounting. Sold each.

- 11183 Shorty muffler



Muffler Hanger for Touring Models

This is a quality reproduction of the original muffler hanger used on Touring models since 1985. Sold each. Replaces OEM 65724-85.

- 688643 Muffler hanger

6

EXHAUST

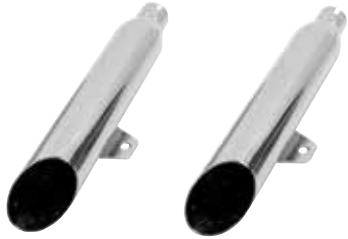

Slash Cut Slip-ons by Paughco

Kit with 3" diameter mufflers complete with bracket and hardware. Fits 00-07 Softails (except FXSTD, FLSTF, FLSTN and FLSTS).

651337 Slash cut slip-ons



280904



280905

Trumpet Mufflers

Very popular years ago, these trumpet mufflers are making a big comeback on the retro-style motorcycles, and are a perfect finishing touch to an early style Bobber or Chopper. 1-3/4" inlet, removable baffles, and universal mounting bracket included. Available in straight, or up-swept styles. Sold each.

280904 19" straight

280905 20" upswept

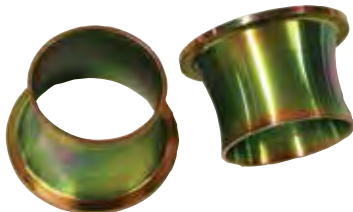

Vulcan Engineering Exhaust Power Cones

Machined from 12L15 Billet Steel Bar

668162 Exhaust Cones

NEW



650166

650165

650164

Chrome Exhaust End Caps by Paughco

Chrome plated CNC-Machined from steel bar stock. Available in 1 3/4" & 2" to fit most aftermarket exhaust systems. Easy to install, slides into place and is held in place using the 1/4" hardware that is provided (drilling a hole in the exhaust pipe may be required). Sold in pair. Made in the U.S.A.

For 1 3/4" Pipes

650164 1-3/4" Diameter Short Curve exhaust end caps

650165 1-3/4" Diameter Long Curve exhaust end caps

650166 1-3/4" Diameter Tapered exhaust end caps

For 2" Pipes

650167 2" Diameter Short Curve exhaust end caps

650168 2" Diameter Long Curve exhaust end caps

650169 2" Diameter Tapered exhaust end caps

650358

650359



650357



Brass Exhaust End Caps by Paughco

CNC-Machined from Brass. Available in 1 3/4" & 2" to fit most aftermarket exhaust systems. Easy to install, slides into place and is held in place

using the 1/4" hardware that is provided (drilling a hole in the exhaust pipe may be required). Sold in pairs and made in the U.S.A.

For 1 3/4" Pipes

650357 Short Curve exhaust end caps, 1 3/4"

650358 Long Curve exhaust end caps, 1 3/4"

650359 Tapered exhaust end caps, 1 3/4"

For 2" Pipes

650360 Short Curve exhaust end caps, 2"

650361 Long Curve exhaust end caps, 2"

650362 Tapered exhaust end caps, 2"



Khrome Werks AR Power Cones

Drop a set of Power Cones into the headpipes of most stock and aftermarket 1 3/4" exhaust systems on Evolution and Twin Cam engines and reap the benefits of the patented 'Anti-Reversionary' design found in Python, AR and ARII high-performance exhausts. They're made of stainless steel. Sold in pairs.

31723 Khrome Werks ar power cones

APPAREL

SEATS & BAGS

FOOT CONTROLS

HAND CONTROLS

LIGHTING

ELECTRICAL

EXHAUST

INTAKE

ENGINE

GASKETS

TRANSMISSION & CLUTCH

DRIVELINE

WHEELS TIRES & BRAKES

CHASSIS

SHEETMETAL

INSTRUMENTS & GAUGES

GENERAL

CROSS REFERENCE

EXHAUST



NEW

660942

660943



660944



660945

TC Bros Choppers Do It Yourself Builder's Exhaust Kits

This kit comes with everything you need to cut and weld a set of custom pipes for your bike and is made right here in the USA! All tubing is 1.75" OD x 16ga Wall (.065" Thick) American Made mild steel for superior weld-ability. All bends are 3.5" centerline radius and are produced using a CNC mandrel bender for accuracy and maximum exhaust flow. Kit includes 2 = 90 degree bends, 2 = 180 degree bends, 3 straight tubing pieces, 2 U-channel mounts, and the proper heavy duty flange set to fit your bike with a leak free seal. This DIY kit is the perfect way to build the unique looking set of pipes you desire!

- 660942** Exhaust kit for Evolution Big Twins, Twin Cams models 84-Up and Sportster models 86-Up
- 660943** Exhaust kit for Shovelhead models 67-83
- 660944** Exhaust kit for Ironhead Sportster models 57-85
- 660945** Exhaust kit for Panhead models 48-66



Exhaust Flange Kit for S.T.D. Shovelhead/Panhead by Vulcan Engineering

- These are perfect for building a one-off custom exhaust system for our 'Pandemonium' or Shovelhead motors
- Designed to fit all S.T.D. 3-bolt Shovelhead and Panhead's
- Made in the U.S.A.
- Sold each

668255 S.T.D. 3-bolt Shovelhead/Panhead exhaust flange



NEW

660946

660948



660947

660949

TC Bros Choppers Do It Yourself Builder's Exhaust Flange Kit

This DIY flange kit is perfect for the exhaust pipe builder who has access to a tubing bender. Tubing is 1.75" OD x 16ga Wall (.065" Thick) American Made mild steel for superior weld-ability. These heavy-duty flanges are designed to be cut in half to desired length and to provide a leak free seal. Made in the USA!

- 660946** Exhaust Flange kit for Evolution Big Twins, Twin Cams models 84-Up and Sportster models 86-Up
- 660947** Exhaust Flange kit for Shovelhead models 67-83
- 660948** Exhaust Flange kit for Ironhead Sportster models 57-85
- 660949** Exhaust kit for Panhead models 48-66



Santee Shotgun Pipe Builders Kit

For Pandemonium & Jammer 88" Shovelheads or Pan/Shovelheads with STD Cylinder Heads

This is the perfect starting point for those one off Shotgun pipes you are looking to build. They are designed to work perfectly with our Pandemonium, Jammer 88" Shovelhead or any Panhead/Shovelhead with STD cylinder heads. This kit comes complete with a front & rear pipe with flanges pre-welded on and 2 channel mounts that can be welded on where-ever you need them. The pipes come in a raw steel so you can cut and weld them up and chrome, paint, or wrap them up however you like. Made in the U.S.A.

650155 Santee Shotgun pipe builders kit.



Kibblewhite Exhaust Spigot for Panhead Models

Repair mangled exhaust spigots. Machined from 6061-T6 extruded tube. Welding required.

55165 Fits all Panhead motors 48-64

6

EXHAUST



688252

Universal Skull Heat Shields

Can't get enough of skulls? Neither can we! These beauties are for your exhaust and come in 12" or 9" lengths and include clamps. They complement many of our other skull design products like air cleaners, gas caps and points covers.

688252 Skull heat shield 12" chrome

688253 Skull heat shield 9" chrome

AVAILABLE IN BLACK

15980



688083

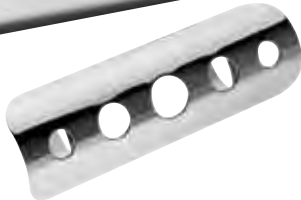

Chrome Exhaust Heat Shield

7" chrome-plated heat shield for all 1 3/4" diameter exhaust pipes. A unique integrated clamp mounts this shield for a neat custom appearance.

15980 Chrome heat shield

688083 Chrome drilled heat shield

688078 Black 7" heat shield

78400

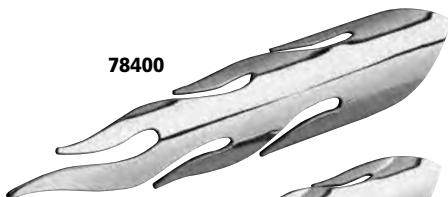

78401

Chrome Flame Universal Heat Shields

Turn a normal exhaust system into something unusual with chrome-plated steel heat shields cut into the shape of flames. Includes clamps. Sold each.

78400 For 2" pipes, 11 3/4"-long

78401 For 1 3/4" pipes, 8"-long



Heat Shields by Paughco

Classic styled universal heat shields available in 5 1/2" or 9" lengths. Sold each.

632272 9" long heat shield with clamp

632273 5 1/2" long heat shield with clamp



Chrome Flexible Exhaust Covers

Originally used on the early Panheads and Knuckleheads, these 12"-long exhaust covers give your bike a 'vintage' look. Fits most 1 3/4" two-piece pipes. Sold each.

15981 Flexible exhaust



Universal Perforated Exhaust Heat Shield

Chrome-plated 11"-long universal heat shield fits a range of pipe and muffler sizes from 1 3/4" to 3". Ideal for Shotgun or upswept exhaust systems. Sold each.

08877 Heat shield



Universal Exhaust Pipe Heat Shield

7"-long universal heat shield fits a range of pipe sizes from 1 1/2" to 2". Ideal for protection on Shotgun or upswept systems. Sold each.

15990 Universal heat shield



280033

Exhaust Pipe Heat Shields for FL Models

Fits stock exhaust pipes on 4-speed FL models from 70-84 with single or dual exhaust. Includes shield and clamps.

280033 Front pipe heat shield (repl. OEM 65561-70)

APPAREL

SEATS & BAGS

FOOT CONTROLS

HAND CONTROLS

LIGHTING

ELECTRICAL

EXHAUST

INTAKE

ENGINE

GASKETS

TRANSMISSION & CLUTCH

DRIVELINE

WHEELS TIRES & BRAKES

CHASSIS

SHEETMETAL

INSTRUMENTS & GAUGES

GENERAL

CROSS REFERENCE

EXHAUST



Muffler Joint Gaskets

These copper gaskets are used to seal the joints between the mufflers and the headpipes on all FLT, FLHT, FLHS and Road King models from late 85-94. Pack of 10.

54230 Replaces OEM 65721-85



Exhaust Stud-Nut and Gasket Kit for Shovelheads

Included in this kit are two 'Tuff Seal' exhaust port gaskets. These new-style gaskets make all others obsolete. The kit also prevents thread stripping in the heads by using two permanent studs. Includes four studs, two 'Tuff Seals' and two chromed nugget nuts with lock-washers. Fits Shovelheads from 66-84.

25067 Sold on a card of 5 sets

6



Extra Wide Aircraft Style Exhaust Clamps

1 1/16" wide from heavy wall 1/8" thick steel to offer an improved seal and better support for the exhaust system.

380103 Fits Panhead models 48-65. 2 1/8".



Wide Aircraft-Style Chrome Exhaust Clamps

These custom clamps measure 1 1/16"-wide and are wider than standard clamps. They were made to provide a better seal and support the exhaust pipes to their flanges. Made from heavy-wall (1/8"-thick) cold-rolled and chrome-plated steel, they have a 1 7/8"-inside diameter which also makes them ideal for attaching mufflers to headpipes. Sold in pairs.

11234 Fit Sportster models from 57-85



Chrome Heavy Duty 'P' Clamps

These heavy duty steel 'P' clamps are 6" long, 7/8" wide and 1/8" thick. Includes pinch bolt with nut and lock washer. Sold each.

380151 Fits 1 3/4"-diameter pipes



Chrome Aircraft-Style Exhaust Clamps

Custom exhaust clamps made of heavy-wall (1/8"-thick), cold-rolled steel, complete with sockethead screws. Sold in pairs.

11101 Fit Sportster models from 57-85 (repl. OEM 65273-88T)

11233 Fit Panheads from 48-65 (repl. OEM 65274-88T)



Muffler Clamp

A highly-polished muffler clamp made of .100" thick stainless steel strap. It's 1"-wide and has a 3 1/4" opening an exact duplicate of the OEM clamp used to support the mufflers on FL models for many years. Sold each.

11214 3 1/4" stainless steel muffler clamp (repl. OEM 65293-58)



Chrome Late Model Muffler Clamps

This two-piece clamp fits all FXRD, FLT, FLHT and FLHS 5-speed models from 85-93. The earlier version was a one-piece clamp which often broke during removal or installation. Each clamp includes all necessary chrome mounting hardware. Sold in pairs.

11427 Replaces OEMs 65722-85, 65722-85B

EXHAUST



Muffler Reducer Sleeve

Zinc-plated muffler reducer sleeve to adapt all 1 3/4" mufflers to 1 1/2" drag pipes. Sold each.

84805 Muffler reducer sleeve



Exhaust Flange Kit for Evolution and Twin Cam Models

Ideal for dress up or exhaust system installations. Contains 2 chrome exhaust flanges, retaining rings, exhaust gaskets and chrome acorn nuts with washers. Fits Evolution Big Twin models from 84-99, Sportster models from 86-13 and Twin Cam models from 99-13.

090021 Complete kit



Exhaust Manifold Clamp

Fits Evolution Big Twins from 84-99, Sportster models from 86-13 and Twin Cam models from 99-13 (see CCI #11426 for exhaust retaining rings). Sold each.

090012 Replaces OEM 65328-83

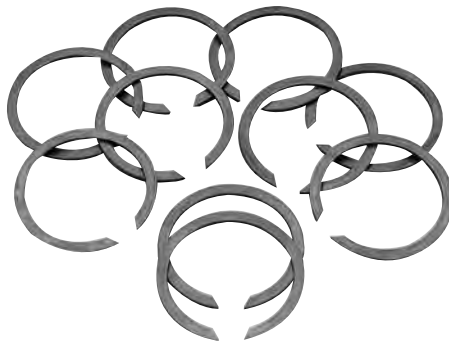

Exhaust Retaining Rings for Evolution and Twin Cam Models

These American-made retaining rings are used to join the exhaust flange and pipe to the cylinder head on all Evolution and Twin Cam Big Twin models from 84-13, and Evolution Sportster models from 86-13.

11426 Replacement retaining rings (repl. OEM 65325-83) pack of 10



Chrome Flange and Retaining Ring Kit for Evolution and Twin Cam Models

This kit includes two new chrome-plated exhaust flanges and a pair of retaining rings. This kit is ideal for anyone building a bike from the ground up, or to upgrade the existing flanges on stock bikes. Replacement retaining rings are also available separately. It fits all Big Twin, Twin Cam and Evolution Sportster motors from 84-13.

11425 Chrome exhaust flange kit

11426 Replacement retaining rings (repl. OEM 65325-83) pack of 10



Late Style Exhaust Flange Set

Reproductions of the OEM late style exhaust flanges used on 04 and later models. The altered design prevents warping that was common for the earlier style exhaust flanges.

688178 Late style exhaust flange set

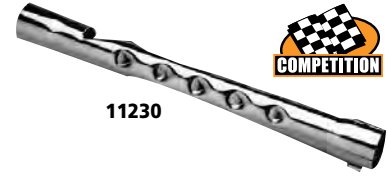

11230



12" Drag Pipe Baffles

These replacement drag pipe baffles are extra-long. Sold each.

11230 Fits 1 1/2"-diameter pipes



11238

11228

11229

4" Mini Pipe Baffles

Short length, full-performance, all-steel baffles for all pipes between 1 1/2" and 2" in diameter. Sold each.

11238 2"-diameter baffle

11229 1 3/4"-diameter baffle

11228 1 1/2"-diameter baffle



280018

Steel Pipe Baffles

8"-long universal steel pipe baffles with mounting bolt. Sold each.

280018 1 3/4"-diameter baffle

280019 2"-diameter baffle

APPAREL

SEATS & BAGS

FOOT CONTROLS

HAND CONTROLS

LIGHTING

ELECTRICAL

EXHAUST

INTAKE

ENGINE

GASKETS

TRANSMISSION & CLUTCH

DRIVELINE

WHEELS TIRES & BRAKES

CHASSIS

SHEETMETAL

INSTRUMENTS & GAUGES

GENERAL

CROSS REFERENCE

EXHAUST

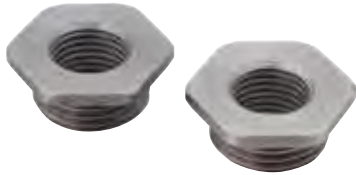

Oxygen Sensor Bung Reducers 18mm to 12mm

These threaded reducer sleeves allow the use of earlier aftermarket exhausts with 18mm bungs on models equipped with 12mm sensors. Harness extensions (CCI#622332) available separately if needed. Sold in pairs.

622331 O2 sensor bung reducers 18mm to 12mm



Oxygen Sensor Adapter Kit

Complete kit that allows the installation of aftermarket exhaust systems with 18mm O2 sensor bungs on models that are equipped with factory 12mm sensors with 4 pin plugs. Includes two sensor bung reducers and 22" harness extensions for the sensors.

622330 O2 sensor adapter kit



Exhaust Crossover Gaskets

These knitted steel gaskets are used in the crossover tube between the front and rear exhaust pipes. They fit sportster and FXR models from 82-99 as well as Fat Boy and FLSTN models from 90-99.

54229 Replaces OEM 65781-82 (pack of 10)

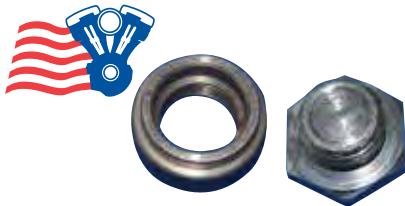

Stainless Steel O2 Sensor Bung and Plugs

Important accessories if you are fitting an early exhaust without O2 sensor ports to a late model bike or a late exhaust to an early bike. Sold each. 18mm thread size.

672534 Weld in sensor bung

672535 Sensor bung plug



Oxygen Sensor Harness Extensions

Used to extend the factory 12mm O2 sensor harness with 4 pin plugs when an aftermarket exhaust is installed that has a different bung location. Harness length is 22". Sold each.

622332 O2 sensor harness extension.



Motor Factory Exhaust Port Gaskets

These knitted wire-mesh crush gaskets are available in either the early-style or the later-style which has been used since 1991. They may be installed in all Evolution or Twin Cam motors when fitting Original Equipment or aftermarket exhaust systems. Packs of 10.

12106 Early (repl. OEM 65324-83)

12095 Late (repl. OEM 65324-83A)



Oxygen Sensor Bung Plugs

Used to seal unused O2 sensor bungs. Available for 18mm and 12mm bungs. Sold each.

688189 Sensor bung plug 18x1.5mm

688190 Sensor bung plug 12x1.25mm



Motor Factory 'Tuff Seal' Exhaust Port Gaskets

The finest exhaust port gasket available. Born on the track, they inherited their racing lineage from head gaskets used in high-horsepower applications. The 'Tuff Seal' is a metal-core, silicone-impregnated material that has a tough alloy ring around the inside edge to keep exhaust gases from escaping and to ensure a faultless pipe-to-head seal. Fit Shovelheads from 66-84. Pack of 10.

12100 Tuff Seal



Oxygen Sensor Socket Tool

This tool is used to remove or install the oxygen sensor on all closed loop fuel injected H.D. models. Socket has a 3/8" drive receiver or can be used with a 7/8" wrench. Socket will withstand up to 125 ft/lbs of torque.

640091 For use on all EFI models 06-11 (except 10- touring)

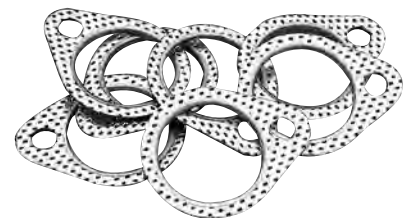

High-Performance Exhaust Gaskets

These high-tech gaskets feature a stainless steel-clad, heat-resistant material. They also have a tough, alloy ring around the inside edge to keep exhaust gasses from escaping and to insure a faultless seal between the pipe and the exhaust port of all Shovelhead engines from 66-84. Pack of 10.

12099 High-performance exhaust gaskets (repl. OEM 65835-86T)

EXHAUST



Shovelhead Exhaust Flange Bolts

Sockethead bolts for the exhaust flanges on Shovelheads from 66-84.
25064 Replaces OEM 3201W (card of 24)



JIMS Exhaust Stud Drill Plate

Guides and aligns the drill bit when removing broken exhaust studs. Use with a tap after to clean the threads. Can be used in the frame. Includes drill bit.

20940 For Evolution and Twin Cam models



Muffler Hanger for Touring Models

This is a quality reproduction of the original muffler hanger used on Touring models since 1985. Sold each. Replaces OEM 65724-85.
688643 Muffler hanger



Exhaust Studs and Nuts by James Gaskets

Quality replacement exhaust studs and nuts. Exhaust studs are sold in pairs, exhaust nuts are sold in packs of eight.

667505 Exhaust studs (pair)

667506 Exhaust flange nuts (8)



Exhaust Stud and Nut Kit

Set of four exhaust studs with nuts for Evo Big Twins 84-99, Sportsters 86-14 and Twin Cams 99-14. Set of 4.

688595 Exhaust stud and nut kit. Replaces OEM 16715-83.

APPAREL

SEATS & BAGS

FOOT CONTROLS

HAND CONTROLS

LIGHTING

ELECTRICAL

EXHAUST

INTAKE

ENGINE

GASKETS

TRANSMISSION & CLUTCH

DRIVELINE

WHEELS TIRES & BRAKES

CHASSIS

SHEETMETAL

INSTRUMENTS & GAUGES

GENERAL

CROSS REFERENCE

EXHAUST



664506

664500

664511



664512

Exhaust Pipe Wrap

- Fiberglass construction for maximum heat insulation and fuel burn
- Perfect for wrapping pipes and mufflers to hide blue chrome and add a custom look
- Wrapping pipes will increase horsepower and help reduce radiated heat
- Available in 1" or 2" width and in a variety of colors
- Stainless steel locking ties available separately

6

Tan

- 664500 1" x 50' tan exhaust wrap
- 664501 1" x 15' tan exhaust wrap
- 664502 2" x 50' tan exhaust wrap
- 664503 2" x 15' tan exhaust wrap

Black

- 664504 1" x 50' black exhaust wrap
- 664505 1" x 15' black exhaust wrap
- 664506 2" x 50' black exhaust wrap
- 664507 2" x 15' black exhaust wrap

Titanium

- 664508 1" x 50' titanium exhaust wrap
- 664509 1" x 15' titanium exhaust wrap
- 664510 2" x 50' titanium exhaust wrap
- 664511 2" x 15' titanium exhaust wrap

Stainless Steel Cable Ties

Ideal for use in high heat applications, locks tightly and won't slip

- 664512 8" Stainless Steel cable ties (pack of 8)
- 664513 14" Stainless Steel cable ties (pack of 4)



Exhaust Wrap and Tie Kits by DEI

Kits include one roll of 2" x 25ft pipe wrap and four 8" stainless steel locking ties to secure wrap. Note: 8" locking ties can be used on pipes up to 2" in diameter, for larger pipes two ties can be joined together.

- 660825 Black wrap and locking tie kit
- 660826 Tan wrap and locking tie kit
- 660827 Titanium wrap and locking tie kit



660825

660827

660826

EXHAUST



APPAREL
SEATS & BAGS
FOOT CONTROLS
HAND CONTROLS

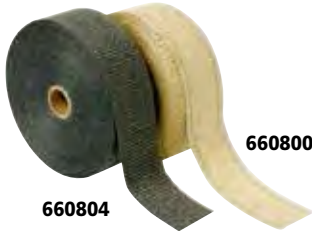

660804

660800

**NEW
FITMENTS**



660810

660811

660809

660813



660814



660836

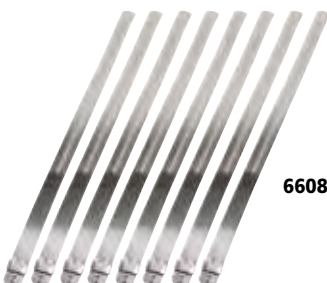

660834



LIGHTING
ELECTRICAL

DEI Exhaust Wrap Kit

Motorcycle exhaust wrap for custom, stock or racing applications. It helps keep exhaust cooler giving you more horsepower. Can be used to cover blued exhaust. Available in tan, black or titanium colors. Black and tan wraps withstand 1200°F direct / 2000°F radiant. Titanium Wrap withstands 1800°F direct / 2000°F radiant.

Tan Exhaust Wrap

Fits all applications

- 660800** Tan exhaust wrap 1" x 50 ft.
- 660801** Tan exhaust wrap 2" x 50 ft.
- 660802** Tan exhaust wrap 1" x 15 ft.
- 660803** Tan exhaust wrap 2" x 15 ft.

Black Exhaust Wrap

Fits all applications

- 660804** Black exhaust wrap 1" x 50 ft.
- 660805** Black exhaust wrap 2" x 50 ft.
- 660806** Black exhaust wrap 1" x 15 ft.
- 660807** Black exhaust wrap 2" x 15 ft.

Titanium Exhaust Wrap

Fits all applications

- 660808** Titanium exhaust wrap 1" x 50 ft.
- 660809** Titanium exhaust wrap 2" x 50 ft.
- 660810** Titanium exhaust wrap 1" x 15 ft.
- 660811** Titanium exhaust wrap 2" x 15 ft.
- 660812** Titanium exhaust wrap 2" x 25 ft.

Exhaust Wrap Stainless Steel Locking Ties

Made from 304 stainless steel. Tensile strength 100 lbs.

- 660813** Stainless locking ties 8" long x 3/16" wide (8 per pack)
- 660814** Stainless locking ties 14" long x 3/16" wide (4 per pack)

Exhaust Wrap Stainless Steel Positive Lock Ties

Locking teeth so tie won't come loose. Made from 316 stainless steel. Tensile strength 7mm= 200lbs, 12mm 350 lbs.

- 660833** Stainless locking ties 9" long x 7mm wide (8 per pack)
- 660834** Stainless locking ties 9" long x 12mm wide (8 per pack)

Stainless Steel Locking Tie Tool

DEI has developed an effective tool to tighten stainless locking ties. This tool saves time, hassle, and gives a professional looking result. Simply slide the tool on the end of any " nut driver, engage the tie, and twist. This gets the tie nice and secure, without any hassle. Works on any stainless ties up to 12mm (1/2") wide. Sold each.

- 660836** Locking stainless tie tool

EXHAUST

INTAKE

ENGINE

GASKETS

TRANSMISSION
& CLUTCH

DRIVELINE

WHEELS
TIRES &
BRAKES

CHASSIS

SHEETMETAL

INSTRUMENTS
& GAUGES

GENERAL

CROSS
REFERENCE

EXHAUST



NEW



DEI Flexible Heat Shield

Thinking beyond the traditional stainless steel or carbon fiber heat shields, DEI developed a flexible heat shield solution that outperforms other shields available today. This enhanced performance starts by joining two durable materials together forming a dual-layer design. The outer layer is made from heat-treated glass fiber that is bonded with molten aluminum made into a tight weave for durability and strength. The inside material is made of a special high temperature resistant fabric (89% silica) designed to withstand some serious exhaust heat. The result is a product with unmatched thermal performance good up to 1350°F and finished off with a pleasing rich black finish. Universal fitment to fit from 1-3/4" up to 2-1/2" pipes for many applications since the shield remains flexible. Includes stainless steel hardware. Measures 8" long x 4" wide. Made in the USA.

660835 Black heat shield



6



660820



660821



660819

DEI Motorcycle Exhaust Wrap Kit

Kits come with everything you need to wrap your pipes.

Kit contains

- Two 2" x 15 ft. rolls of pipe wrap
- Eight 8" stainless steel locking ties
- Four 14" stainless steel locking ties
- 12 oz. can of HT Silicone Coating spray (black, aluminum or white)

Pipe Wrap Kit

Fits custom applications

- 660819** Exhaust wrap black w/black HT Silicone Coating
660820 Exhaust wrap tan w/aluminum HT Silicone Coating
660821 Exhaust wrap tan w/white HT Silicone coating



660816

660817

660818



DEI HT Silicone Coating

HT Silicone Coating provides lasting protection for any hot surface. Recommended for use with DEI Exhaust Wrap. It has great sealing properties against oil, grease, dirt, harsh abrasives, and road grime. HT Silicone Coating works equally well on exhaust header, pipes, and engine blocks. HT Silicone Coating is able to withstand temperatures up to 1500°F.

HT Silicone Coating

Works with all custom applications.

- 660816** Black HT Silicone Coating
660817 Aluminum HT Silicone Coating
660818 White HT Silicone Coating
660815 HT Silicone assortment case. DEALER 6-PACK (2 each of black, white and aluminum)