

**2015**

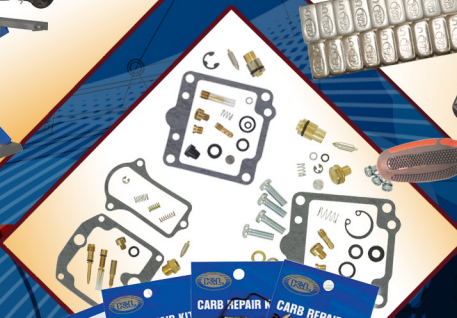

**K&L SUPPLY CO.**



**Since 1968**

**Leading the Powersports Industry in Equipment • Tools • Hard Parts**





***SERVICE CENTER***  
***SECTION 1***  
***Lifts, Jacks And Stands***

## MC655R HYDRAULIC LIFT

K&L# 35-6564 - Red

K&L# 35-6568 - Blue

K&L# 35-6617 - Black / Orange

**New!**



35-6617

35-6564

35-6568

Accessories shown on lift are not included



35-6564

5-Position Safety Locking System

Integrated Hydraulic Pump For MC655R

Remote Switch Included



Visit for Demos!  
shoplift.klsupply.com

### MC655R HYDRAULIC LIFT

The MC655R from K&L Supply is the next step up in high performance lifts. Along with a 48" maximum raised height and 1 ton capacity, the MC655R features a hand held remote control and a frame mounted pump. This does away with pump stands and excess hose, keeping your service bays clear of extraneous clutter. Optional side panels, now with our redesigned fastmount system, increase the working width of the MC655R Hydraulic Lift to 56.5 or 68.5 inches, allowing the widest utility vehicles and golf carts to be serviced.

With a full range of available options, the MC655R can be tailored to meet any shops' requirements, whether you service bikes, trikes, quads, or carts. K&L's build standard is reflected in the CE certification that the MC655R carries, our commitment to quality has never been easier to harness for your shop.

- Built-in 110V Hydraulic Pump
- Hand Held Remote Control
- 29.5" x 86.5" deck
- Front and Rear Drop Panels
- Five position automatic locking system
- Loading ramp included.

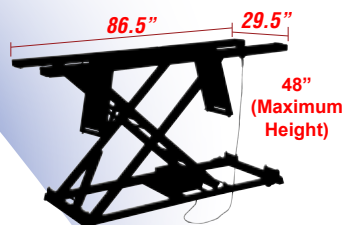

### SPECIFICATIONS

Capacity	2,000 lb.
Width	29.5"
Width w/ Side Panels	56.5" or 68.5"
Length	86.5"
Maximum Height	48"
Minimum Height	7.5"
Weight	500 lb.
Drop Panel	Front & Rear
Wheels	Yes (option)
Warranty	1 year

SHOP EQUIP & TOOLS

HARD PARTS

CARB & FUEL

IGNITION/ELECTRICAL

CONTROL

SUSPENSION

ACCESSORIES



## MC500R HYDRAULIC LIFT

**K&L# 35-4502 - Red Model**

**K&L# 35-4500 - Blue Model**



35-4500

5-Position Safety Locking System

Integrated Hydraulic Pump For MC500R

Remote Switch Included



**Visit for Demos!**

[shoplift.klsupply.com](http://shoplift.klsupply.com)

### MC500R HYDRAULIC LIFT

The MC500R from K&L Supply is the first step in high performance, hydraulic lifts. Along with a 39" maximum raised height and an 1,100 lb. capacity, the MC500R features a hand held remote control and a built-in, 110v, frame mounted hydraulic pump. This does away with pump stands and excess hose, keeping your service bays clear of extraneous clutter.

With a full range of available options, the MC500R can be tailored to meet any shops' requirements, whether you service bikes, quads and/or carts. K&L's build standard is reflected in the CE certification that the MC500R carries, our commitment to quality has never been easier and more affordable to harness for your shop.

- Built-in 110V Hydraulic Pump
- Hand Held Remote Control
- 1,100 lb. Capacity
- 24" x 84" deck dimensions @ 39" Max Height
- Rear Drop Panel
- Five position automatic locking system
- Loading ramp included.
- Optional long ramp (35-0306)
- Optional Side Panels Increase width from 24" to 48" (35-6295)

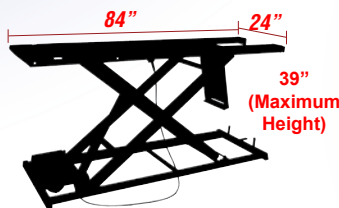

### SPECIFICATIONS

Capacity	1,100 lb.
Width	24"
Width w/ Side Panels	48"
Length	84"
Maximum Height	39"
Minimum Height	7.25"
Weight	365 lb.
Drop Panel	Rear
Wheels	Yes (option)
Warranty	1 year

SHOP EQUIP & TOOLS

HARD PARTS

CARB & FUEL

IGNITION/ELECTRICAL

CONTROL

SUSPENSION

ACCESSORIES

**MC625R HEAVY DUTY AIR LIFT**

**K&L# 35-6350 - Blue**

**K&L# 35-6355 - Red**

**K&L# 35-6368 - Black**

**K&L# 35-6616 - Black / Orange**



**5-Position Safety Locking System**

**The Ram Squared Twin Cylinder System**

**CE Certified Dual-Pedal**



**MC625R HEAVY DUTY AIR LIFT**

The MC625R Heavy Duty Air Lift is how K&L Supply defines Air Superiority. This lift combines the best features of our MC655R hydraulic lift with the convenience of air. The new Ram Squared twin cylinder system gives the MC625R Heavy Duty Air Lift a rated working capacity of 1750 lbs. Optional side panels, now with our redesigned fastmount system, increase the working width of the MC625R Heavy Duty Air Lift to 56.5 or 68.5 inches, allowing the widest utility vehicles and golf carts to be serviced. An easy to install extension is also available, adding two feet front or rear to the overall length for custom bikes. Combine those features, plus the value you expect from K&L and you have a lift that will be right for all of your needs.

- 1,750 lb. Max Capacity
- 29.5 x 86.5 deck
- Drop panels at front and rear of lift
- Max raised height of 40 inches
- Lowered height is 8.5 inches
- Automatic safety lock
- Loading ramp included
- One Year Warranty

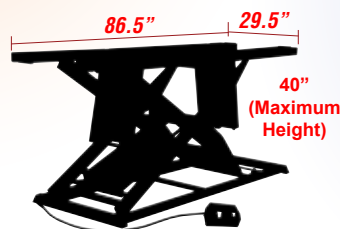

**SPECIFICATIONS**

Capacity	<b>1,750 lb.</b>
Width	29.5"
Width w/ Side Panels	56.5" or 68.5"
Length	86.5"
Maximum Height	40"
Minimum Height	8.5"
Weight	540 lb.
Drop Panel	Front & Rear
Wheels	Yes (option)
Warranty	1 year

**Visit for Demos!**

[shoplift.klsupply.com](http://shoplift.klsupply.com)

SHOP EQUIP & TOOLS

HARD PARTS

CARB & FUEL

IGNITION/ELECTRICAL

CONTROL

SUSPENSION

ACCESSORIES



**MC615R AIR LIFT**

**K&L# 35-6292 - Blue Model**

**K&L# 35-6294 - Red Model**

**K&L# 35-6254 - Black Model**



SHOP EQUIP & TOOLS

HARD PARTS

CARB & FUEL

IGNITION/ELECTRICAL

CONTROL

SUSPENSION

ACCESSORIES

35-6294

CE Inspection

CE Inspection

CE Certified Dual-Pedal



35-6370



**MC615R AIR LIFT**

K&L has brought a new level of quality to the market with the MC615R. This lift is proof that K&L Quality can be enjoyed by every shop. The MC615R has a rated working capacity of 1000 lbs, making it perfect for Sportbikes and standards especially when used with our Lifting Arm Kits. Optional side panels increase the working deck width to 48".

- 1000 lb. Max Capacity
- Rear Drop Panel
- Max raised height of 35"
- Lowered height is 7.25"
- Automatic safety locks
- Loading ramp included
- One year warranty
- 24" x 84" deck

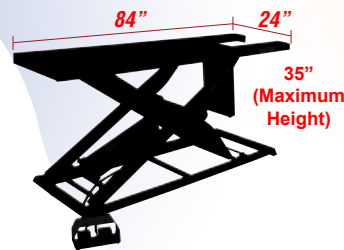

**SPECIFICATIONS**

Capacity	<b>1,000 lb.</b>
Width	24"
Width w/ Side Panels	48"
Length	84"
Maximum Height	35"
Minimum Height	7.25"
Weight	365 lb.
Drop Panel	Rear
Wheels	Yes (option)
Warranty	1 year

**Visit for Demos!**

[shoplift.klsupply.com](http://shoplift.klsupply.com)

# K&L LIFT ACCESSORIES

SHOP EQUIP & TOOLS

HARD PARTS

CARB & FUEL

IGNITION/ELECTRICAL

CONTROL

SUSPENSION

ACCESSORIES



**Lift Extension Kit**  
35-0318

Does not include Mounting Rails



**MC10R Deluxe Wheel Clamp**  
35-4040

Patents  
6,575,310 &  
6,935,619



**Crank Style Wheel Vise**  
35-9926



**Wheel Stop**  
35-6567

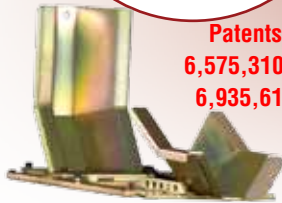

**37-0347 Portectors**



**35-4041 Optional Narrow Rocker**

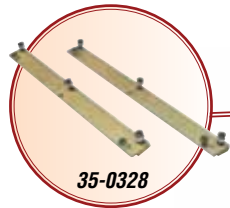

**35-0328**

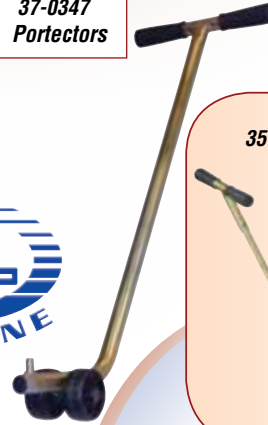

**35-6770 Nose Wheel**

## K&L LIFT ACCESSORIES

K&L#	Descriptions	MC655R	MC650R	MC625R	MC615R	MC600	MC500R
00-7844	K&L Shop Equipment Demos on CD	0	0	0	0	0	0
35-0306	Extended Ramp. For bikes with low ground clearance. 15" W x 45-3/8" L. Diamond plate.	0	0	0	0	—	0
35-0318	Lift Extension Kit. Adds 30" to your lift;	0	0	0	0	0	0
35-0321	Retractable Wheels MC500R/615R/625R/650R/655R Lifts	0	0	0	0	—	0
35-0328	Mounting Rails for Lift Extension	0	0	0	0	0	0
35-4040	MC10R Deluxe Wheel Clamp. Universal Self locking clamp allows one person to load bikes on K&L lifts or any other flat deck lift. (drilling req.) Includes std. width rocker. (Fits 120 to 160 series tires)	0	0	0	0	0	0
35-4041	Optional narrow rocker for MC10R Deluxe Wheel Clamp. Fits narrow wheels. (90 to 110 series tires)	0	0	0	0	0	0
35-5995	Standard Side Panel Ramps for MC655R/MC625R 30.5" x 10.5"	0	0	0	—	—	—
35-5996	Long Side Panel Ramps for MC655R/MC625R 47.0"x10.5"	0	0	0	—	—	—
35-6295	Side Panel Set for MC500R & MC615R. (Gray) Increases width from 24" to 48". Includes Panels (qt 4) and Ramps (qt 2)	—	—	—	0	—	0
35-6255	Side Panel Set for MC500R & MC615R.-Black	—	—	—	0	—	0
35-6367	MC625R/ MC615R Pedal Sold /ea	—	—	0	0	—	—
35-6370	CE Approved Pedal Assembly for MC615R/MC625R. Covered dual pedals reduce chances of accidental actuation. Also stops up/down travel of lift when operator releases either pedal.	—	—	0	0	—	—
35-6371	MC625R/ MC615R Pedal Rebuild Kit.Includes Plunger with Orings and Springs	—	—	0	0	—	—
37-6470	MC615R/ MC500R Tool Holder (2pc set)	—	—	—	0	—	0
37-6471	MC625R/MC650R/MC655R Tool Holder (2pc set)	0	0	0	—	—	—
35-6542	Trike Standard Side Panel Set for MC655R/MC650R/MC625R Contact Area =23.5"x13.2" Does not include Ramps	0	0	0	—	—	—
35-6543	Trike Wide Side Panel Set for MC655R/MC650R/MC625R Contact Area =23.5"x19.5" Does not include Ramps	0	0	0	—	—	—
35-6549	3000lbs Relief Valve	—	0	—	—	—	—

Front/Rear Extension Panel.  
35-6374(Black)



Front/Rear Extension Panel.  
35-6557(Gray)



**New!**

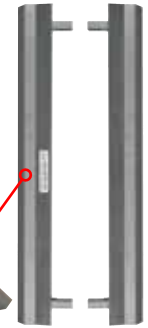

**Tool Holder**  
(MC655R/MC650R/MC625R)  
37-6471  
**Tool Holder**(MC615R/MC500R)  
37-6470



All K&L Lifts and the  
Dual-Pedals on the MC625R  
& MC615R are CE Certified.  
35-6370 - Pedals



35-7779 MC625R Air Cylinder Replacement Seal Set



Retractable Wheels 35-0321

## K&L LIFT ACCESSORIES

K&L#	Descriptions	MC655R	MC650R	MC625R	MC615R	MC600	MC500R
35-6552	Side Panel Set for K&L MC655R/MC625R Increases overall deck surface width to 56.5" Includes (qt-4) Side Panels 13.5" x 43.3" & (qt-2) Std Ramps	0	0	0	—	—	—
35-6552L	Side Panel/Long Ramp Set for K&L MC655R/MC625R Increases overall deck surface width to 56.5" Includes (qt-4) Side Panels 13.5" x 43.3" & (qt-2) Long Ramps	0	0	0	—	—	—
35-6552T	Trike Side Panel Set for MC655R/MC650R/MC625R Increases deck surface width to 56.5" Includes (qty-2) Side Panels & (qty-2) Standard Ramps	0	0	0	—	—	—
35-6552TW	Wide Trike Side Panel Set for MC655R/MC650R/MC625R Increases deck surface width to 69" Includes (qty-2) Wide Side Panels & (qty-2) Long Ramps	0	0	0	—	—	—
35-6552W	Wide Side Panel Set for K&L MC655R/MC625R Increases overall deck surface width to 69" Includes (qty-2) Long Ramps 10.24" x 46.41" & (qty-4) Wide Panels 19.68" x 43.3"	0	0	0	—	—	—
35-6369	Side Panel Set for K&L MC655R/MC625R. Black	0	0	0	—	—	—
35-6369W	Wide Side Panel Set for K&L MC655R/MC625R. Black	0	0	0	—	—	—
35-6557	Front/Rear Extension. Adds 24" to deck. Sold Ea. 24" x 29.5"	0	0	0	—	—	—
35-6374	Front/Rear Extension. Adds 24" to deck. Sold Ea. 24" x 29.5" <b>Black</b>	0	0	0	—	—	—
35-6567	K&L Wheel Stop for MC Series Lifts	0	0	0	0	0	0
35-6575	Wide Front/Rear Extension. Adds 24" to deck. Sold Ea. Increase Front or Rear Width to 68.5"	0	0	0	—	—	—
35-6610	Replacement Ramp. 15" W x 29.5" L. Diamond plate.	0	0	0	—	—	—
35-6770	Nosewheel, fits MC500R/MC615R/625R/650R/655R Lifts	0	0	0	0	—	0
35-7778	MC615R Air Cylinder Replacement Seal Set	—	—	—	0	—	—
35-7779	MC625R Air Cylinder Replacement Seal Set	—	—	0	—	—	—
35-9926	Crank Style Wheel Vise	0	0	0	0	0	0
35-9251	MC600 Replacement Air Control Valve	—	—	—	—	0	—
37-0299	MC650R Cylinder Replacement Seal Set	—	0	—	—	—	—
37-0347	Crank Style Wheel Vise/Wheel Protectors	0	0	0	0	0	0
37-9018	MC600 Replacement Piston Seal	—	—	—	—	0	—
37-9912	Wheel Vise Bushing for 35-9926 Vise. Sold each.	0	0	0	0	0	0



# LIFT PANEL EXTENSIONS

## FRONT & REAR EXTENSION

Extend the Deck 24 inches! These extensions can be used on either end or use 2 for 48".

- 35-6557** 24"x29.5" Extension Panel for K&L MC655R/MC650R/MC625R Gray
- 35-6374** Front/Rear Extension. Adds 24" to deck. Sold Ea. 24" x 29.5" Black
- 35-6575** Wide Front/Rear Extension. Adds 24" to deck. Sold Ea. Increase Front or Rear Width to 68.5"



SHOP EQUIP & TOOLS

HARD PARTS

CARB & FUEL

IGNITION/ELECTRICAL

CONTROL

SUSPENSION

ACCESSORIES

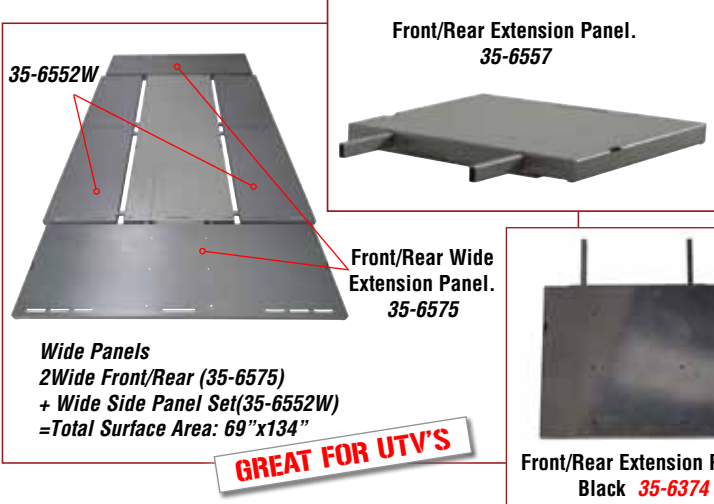

**Wide Panels**  
2Wide Front/Rear (35-6575)  
+ Wide Side Panel Set(35-6552W)  
=Total Surface Area: 69"x134"

**GREAT FOR UTV'S**

## SIDE PANEL SET, LOADING RAMP

Standard Side Panels are 13.5" / each, which is 27 extra inches of deck surface space, or a total of 56.5". The Extra Wide Side Panels are 19.68" / each, which means that you get 39" extra inches of deck surface space, or a total of 68.5". Ramps are sold in Pairs and Side panels are sold in Sets.

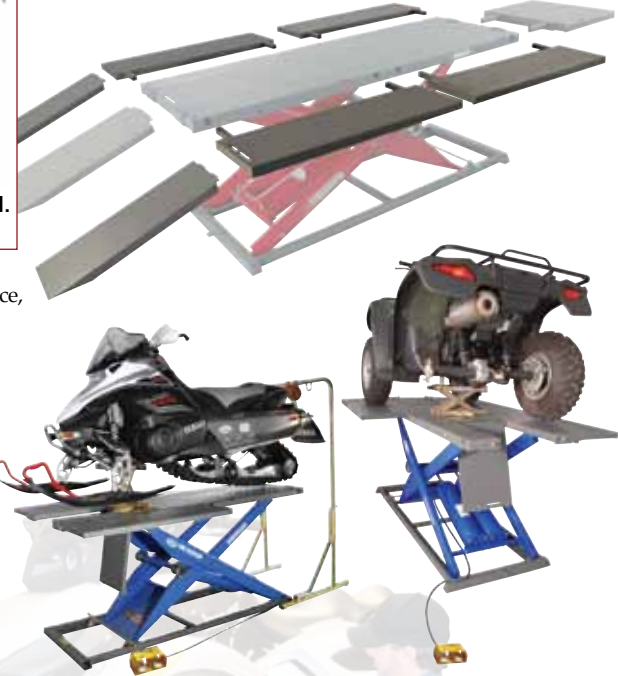

- 13.5"**  
**STD Panels**  
**35-6552**
- 19.68"**  
**Wide Panels**  
**35-6552W**
- Trike STD Panels**  
**35-6542**
- Trike Wide Panels**  
**35-6543**



- 35-6552** Side Panel Set for K&L MC655R/MC625R Increases overall deck surface width to 56.5" Includes (qt-4) Side Panels 13.5"x 43.3" & (qt-2) Standard Ramps
- 35-6369** Side Panel Set for K&L MC655R/MC625R. Black
- 35-5995** Standard Side Panel Ramps for MC655R/MC625R 30.5" x 10.5"
- 35-5996** Long Side Panel Ramps 10.24"x46.41" for MC655R/MC625R
- 35-6552L** Side Panel/Long Ramp Set for K&L MC655R/MC625R Increases overall deck surface width to 56.5" Includes (qt-4) Side Panels 13.5"x 43.3" & (qt-2) Long Ramps
- 35-6552W** Wide Side Panel Set for K&L MC655R/MC625R Increases overall deck surface width to 68.5" Includes (qty-2) Long Ramps 10.24"x46.41" & (qty-4) Wide Panels 19.68"x 43.3"
- 35-6369W** Wide Side Panel Set for K&L MC655R/MC625R. Black
- 35-6542** Trike Side Panel Set. Does not include Ramp 23.5" x 13.2"
- 35-6543** Trike Wide Side Panel Set for MC655R/MC650R/MC625R Contact Area =23.5"x19.5" Does not include Ramp
- 35-6552T** Trike Side Panel Set for MC655R/MC650R/MC625R Increases deck surface width to 56.5" Includes (qty-2) Standard Side Panels & (qty-2) Ramps
- 35-6552TW** Wide Trike Side Panel Set for MC655R/MC650R/MC625R Increases deck surface width to 68.5" Includes (qty-2) Wide Side Panels & (qty-2) Long Ramps
- 35-6295** Side Panel Set for K&L MC500R/MC615R. Increases overall deck surface width to 48" Includes (qt-4) Standard Panels and (qt-2) Ramps
- 35-6255** Side Panel Set for K&L MC500R/MC615R. Black

## K&L LIFT/WORK STAND ACCESSORY BRACKET

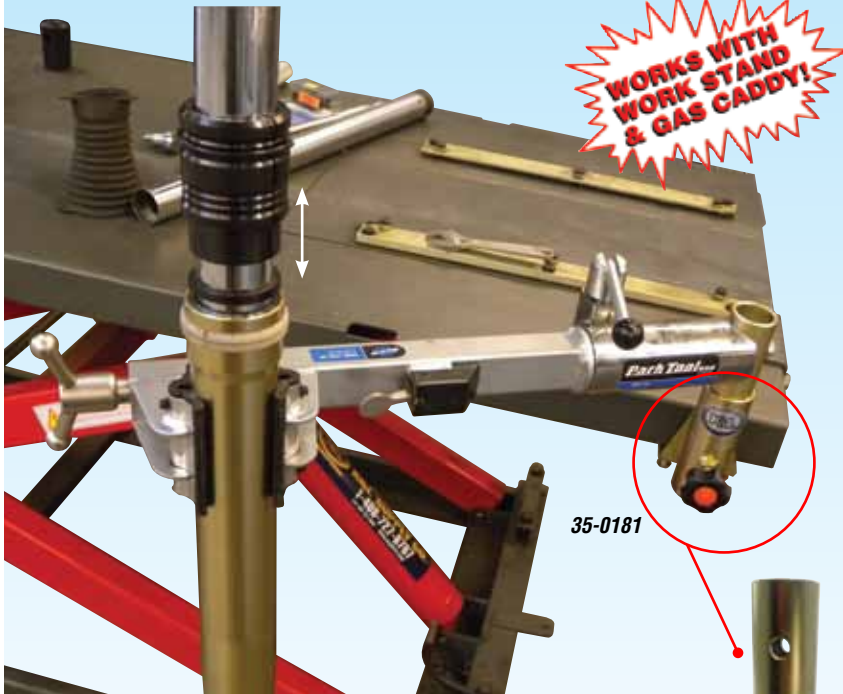

35-0181

35-0181 Work Stand Accessory Bracket Eliminates the need for any of the Park Tool mounting brackets. This Bracket slides into any K&L Lift with a square slot in the Lift platform! It is also designed to mount the K&L Gas/Fan Caddy (P/N:35-8166) to any K&L Lift!

The K&L Accessory Bracket with the Work Stand is perfect for jobs like Installing Fork Seals!

### PARK TOOL WORK STAND (Pictured above)

The Work Stand is designed to safely and securely hold odd shaped components such as fork stanchions, sliders, carbs, rear shocks, pistons, etc. The 360° rotation of the clamp makes servicing from all angles a breeze. These Work Stands feature adjustable clamping pressure for components up to 4 inches (100mm) in diameter. Non-marring, replaceable jaw inserts provide a firm grip on items up to 80 lbs.

- 35-5997 PRS-3MLB Work Stand. Height Adjusts from 50 to 60" Includes aluminum tool tray. **Note: Base not included.**
- 35-5998 Floor Plate for 35-5997. Allows it to not be mounted to the floor.
- 35-5999 Floor Plate for 35-5997. Allows stand to be mounted to any flat surface. **Will Not convert PRS-3MLB to a freestanding unit.**
- 35-5000 PRS-4M Bench Mounted Work Stand. Attaches easily to any flat surface. **(fasteners not included)**
- 35-4999 PRS-4WM Wall Mounted Work Stand. Designed to easily mount to any post or wall stud. **(fasteners not included)**
- 35-4990 Replacement Jaw Covers for all workstands shown (Sold in pairs)

35-5997 Work Stand



35-5000 Bench Mounted Work Stand



35-4999 Wall Mounted Work Stand



35-8166

35-8188 Flat Tray

35-0181

EQUIPMENT SHOWN NOT INCLUDED

### K&L "FIXED" AUXILIARY GAS & FAN CADDY

This tool offers mobility by centralizing all required tools on one easy to use fixture and now features an additional shelf for increased storage. Constructed of square tubing, the height is adjustable up to 68" with hooks to attach gauges and fuel bottles. The stand is finished in blue powder coat and Zinc Plated.

- 35-8166 "Fixed" Gas/Fan Caddy (Fits into 35-0181 Lift Bracket)
- 35-0181 Lift Accessory Bracket
- 35-8188 Flat Accessory Tray (mounts to 35-8166 Gas/Fan Caddy)
- 35-2373 "Fixed" Gas/Fan Caddy Kit:  
(Includes: Qty-1 35-8166, Qty-1 35-0181 & Qty-1 35-8188)



35-5000

35-0181

The K&L Lift/Workstand adapter slides into any K&L Lift that has the square holes in the platform and locks with the bolts (provided).

SHOP EQUIP & TOOLS

HARD PARTS

CARB & FUEL

IGNITION/ELECTRICAL

CONTROL

SUSPENSION

ACCESSORIES



## K&L MC465 - UTV / TRIKE JACK

The wide footprint offers the stability you need when working on these units and keeps the weight centered, an important safety consideration.

**NOTE: Do not use air/impact guns to raise and lower the MC465**

- 37-8787 K&L MC465 UTV Jack
- 37-8002 Replacement Thrust Bearing for Jack
- 37-8788 MC465 UTV Jack Rebuild Kit
- 37-9889 Socket for All K&L Jacks



37-8787

### MC465 Dimensions:

- Max Load Capacity = 1100 lbs
- Minimum Height = 3.5"
- Maximum Height = 13"
- Length = 23"
- Width = 5.5"
- Base Width: 12.5"
- Footprint = 4 ft & clears the drop panel width



37-8788

MC465 UTV Jack Rebuild Kit

## H-D® TRIKE ADAPTER SET FOR MC465 JACK

### H-D® TRIKE ADAPTER SET FOR MC465 JACK

37-8794 H-D Trike Adapter For '09-12 Tri-Glide Ultra Classic Models



37-8794



37-9889

with 3/8" Drive

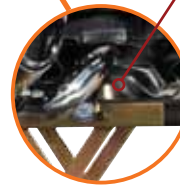

37-8787

## K&L MC455 FAT JACK & MC464 FAT JACK DOLLY

The MC455 Fat Jack is a wide version of our popular MC450 Center Jack, MC464 Fat Jack Dolly works with the MC455. Casters let you move bikes easily, with the stability you need.

**NOTE: Do not use air/impact guns to raise and lower the MC455**

### Dimensions:

- 16" (405mm) Length x 10" (255mm) Width.
- Minimum Height: 3-1/2", Maximum Height: 13"
- Maximum Height: 13" (330mm). Base Width: 14" (355mm)
- Maximum Weight: 1100 lbs (Fat Jack only, Dolly holds up to 800lbs)



37-8660



37-8660 & 35-9872



37-8660 & 37-9694

### MC464 Fat Jack Dolly

37-8662 Rubber Non-Skid Pad also sold separately



37-8660



13"



13-1/2"



4"

37-9694

SHOP EQUIP & TOOLS

HARD PARTS

CARB & FUEL

IGNITION/ELECTRICAL

CONTROL

SUSPENSION

ACCESSORIES

## K&L MC450 CENTER JACK

This easy to use scissor jack is the answer for raising bikes and ATV's, add our post adapter kit for even more flexibility. UPS shippable.

**NOTE:** Do not use air/impact guns to raise and lower the MC450

### Dimensions:

- 16"(405mm) Length x 5-1/2"(135mm) Width.
- Minimum Height: 3-1/2"
- Maximum Height: 13"(330mm).
- Base Width: 14"(355mm)
- Maximum Weight: 1100 lbs.

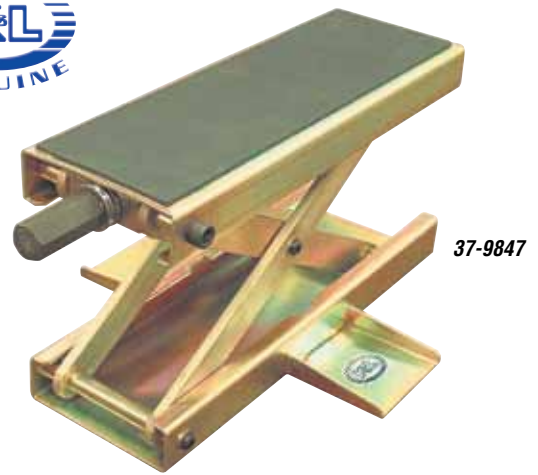

- 37-9841 K&L MC450 Center Jack
- 36-9830 MC450 Rubber Non-Skid Pad-(optional)
- 37-7345 Adapter kit for New Generation Yamaha V-Max
- 37-9534 K&L Sport Jack Adapter for MC450
- 37-9888 Post Adapter Kit for MC450 Center Jack
- 37-9134 MC450 Repair Kit-Fit's MC450's mfg. from 1999 on
- 37-9135 MC450 Retro Fit Repair Kit-Fit's MC450's mfg. before 1999
- 37-9847 MC450 Center Jack with Pad
- 37-9889 Socket for All K&L Jacks
- 37-8002 Replacement Thrust Bearing for Jack
- 00-7844 K&L Shop Equipment Demos on CD

## MC450 Center Jack Adapters

### POST ADAPTER KIT

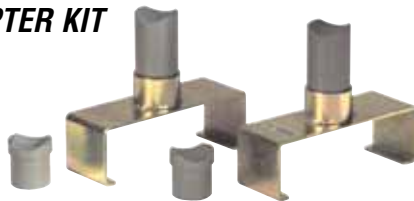

37-9888 MC450 Adapter Kit

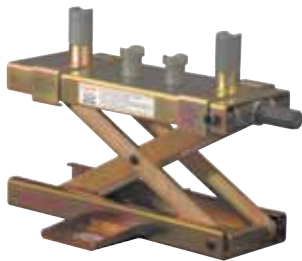

### V-MAX ADAPTER KIT



37-7345 Adapter kit for New Generation Yamaha V-Max

### Jack Repair Kit

37-8002 Replacement Thrust Bearing Set



37-9134 & 37-9135



37-9889 with 3/8" Drive

### SPORT JACK ADAPTER KIT



37-9534

37-9534 K&L Sport Jack Adapter for MC450 includes 24mm adapter

Optional Adapter Set 37-9527 Includes: 28, 32, 36 & 40mm Sleeves



SHOP EQUIP & TOOLS

HARD PARTS

CARB & FUEL

IGNITION/ELECTRICAL

CONTROL

SUSPENSION

ACCESSORIES



SHOP EQUIP & TOOLS

HARD PARTS

CARB & FUEL

IGNITION/ELECTRICAL

CONTROL

SUSPENSION

ACCESSORIES

## K&L MC440 - MINI JACK

The MC440 is a smaller sized version of our popular MC450 Center Jack. It is designed to work with our MC620 - Lifting Arm Kit shown on page 19, and allows you to securely raise the bike being serviced.

**NOTE:** Do not use air/impact guns to raise and lower the MC440

### Dimensions:

- Max Load Capacity = 1000 lbs
- Minimum Height = 3.375"
- Maximum Height = 9"
- Length = 10.25"
- Width = 5.25"

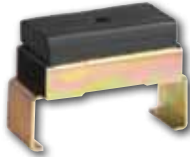

37-9744  
(Adjustable Top Plate)

37-9743



36-9742  
(Rubber Pad also sold separately)



- 37-9743 K&L MC440 Mini Jack
- 36-9742 Rubber Pad for MC440
- 37-9744 Rubber Top Plate for MC440 (adjustable)
- 37-8002 Replacement Thrust Bearing for Jack

## K&L MC460 SHOP DOLLY

The MC460 Shop Dolly allows bikes to be easily moved around the shop. The MC460 works with the MC 450 & MC455 center jacks and our MC550 MultiLift.

### Features include:

- Adjustable width from 13" to 20" at base
- 12" to 15" Adjustable height.
- Swivel neoprene wheels
- Maximum Weight: 1200 lbs.
- Four tie down attachment loops
- Rubber pads on frame rails

- 35-9872 MC460 Shop Dolly

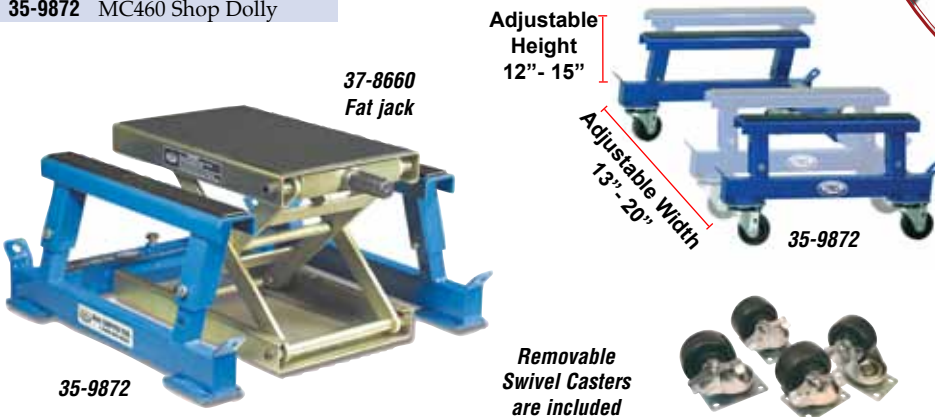

## K&L MC15R CYCLE DOCK

The MC15R Cycle Dock self locking clamp allows one person to load and unload a motorcycle in a trailer, pickup truck or on a service lift. The pivot mechanism uses the weight of the bike to hold itself upright, leaving your hands free to secure the bike. Use the supplied mounting rails to mount the Dock into a trailer or pickup truck. The rails mount to the deck so you can slide the Dock out freeing up your truck or trailer for other uses. The kit includes two mounting rails. Sold Each. **Note:** Tie-Downs recommended but not included.



- 36-4090 K&L MC15R Cycle Dock
- 37-0311 Replacement Rocker Pin
- 36-0308 MC12 Tie-Down Support Bar
- 35-0328 Mounting Rails for Lift Extension Hardware not included
- 00-7844 K&L Shop Equipment Demos on CD
- 35-4041 Narrow Rocker for MC10R/MC15R Chuck



36-4090

Patents  
6,575,310 & 6,935,619

# K&L LIFTING ARM & SPORTJACK ADAPTER

## K&L SPORT JACK ADAPTER

37-9534 K&L Sport Jack Adapter for MC450

(Includes 24mm Adapter)

37-9527 Adapter Set-28, 32, 36 & 40mm sleeves



**MC10R  
Deluxe Wheel Clamp**  
35-4040

**Patents**  
6,575,310 &  
6,935,619



**MC10R Deluxe Wheel Clamp features Universal Fitment**



**SportJack Kit  
for MC450**  
37-9534

Shown with  
37-9841  
Center Jack

**Adapter Set**  
37-9527 Includes: 28,  
32, 36 & 40mm Sleeves



## K&L LIFTING ARM KITS

35-9256 K&L Lifting Arm/Base Set- Includes 35-9820 Base and Arm Set (with 24mm Adapter) for MC500R/MC615R Lifts

35-9257 K&L Lifting Arm/Base Set- Includes 35-9848 Base and Arm Set (with 24mm Adapter) for MC625R/650R/655R Lifts

35-9820 K&L Lifting Arm Base for MC500R/MC615R

35-9848 K&L Lifting Arm Base for MC625R/650R/655R Lifts

35-9821 K&L Lifting Arm Set for Late Model Yamaha R1 and R6 (24mm Adapter Included)

37-9527 Adapter Set: Includes 28, 32, 36 and 40mm Adapter Sleeves

37-9743 MC440 Mini Jack

37-9744 Optional Rubber Top Plate



**Visit for Demos!**  
[shoplift.klsupply.com](http://shoplift.klsupply.com)



**Base Only:**  
MC500R/MC615R: 35-9820  
MC625R/MC650R: 35-9848

**Patent Pending**

**Lifting Arms Only**  
35-9821

**Do not use air impact guns to operate Lifting Arms**



**MC615R Lift**  
1,000 lbs Capacity  
35" Max Height

The K&L Lifting Arm kit lets you safely raise the front or rear end with the bike firmly secured to the lift deck, making suspension, brake, and wheel services faster and easier than traditional methods. Kit consists of one Lifting Arm Base and one set of Lifting Arms.



Gear Driven operation,  
enables precision  
adjustments



Forward  
Position

Mid  
Position

Rear  
Position

**MC440 Mini Jack**  
37-9743



**Optional  
Rubber  
Top Plate**  
37-9744

SHOP EQUIP & TOOLS

HARD PARTS

C/ RB & FUEL

IGNITION/ELECTRICAL

CONTROL

SUSPENSION

ACCESSORIES



# K&L DIRT BIKE LIFT • SWING ARM STANDS

SHOP EQUIP & TOOLS

HARD PARTS

CARB & FUEL

IGNITION/ELECTRICAL

CONTROL

SUSPENSION

ACCESSORIES

## MC475 DIRT BIKE LIFT

Our MC475 lets you do one-armed push-ups, with a Dirtbike! The unique deck cutout helps you perform fluid changes as well as routine maintenance. A single arm is provided for leverage, after the bike is raised, it is easily removed to increase access around the lift. Stop putting your foot down, the MC475 is here!

- 11" minimum height
- 15" maximum raised height
- Deck is 11" x 15", with 6" x 5" cutout
- 400 lb max weight rating

35-6364 MC475 Dirt Bike Lift

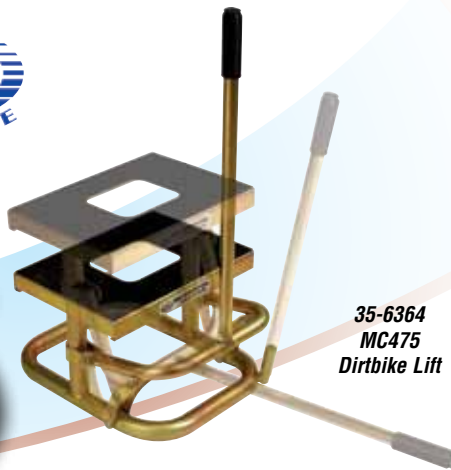

35-6364  
MC475  
Dirtbike Lift

## K&L MC35 SINGLE SIDED SWINGARM STAND

Introducing the latest rear wheel stand from K&L Supply. This single sided swingarm stand has the same quality features that are found in our other rear wheel stands. This swingarm stand can be used on either left or right side wheel applications by adjusting the set screws, where as other stands can only be used on one side. The wheel pins must be purchased separately.

37-9683 K&L MC35 Single Sided Swingarm Stand  
**WHEEL PINS** Sold each.

35-0883 Ducati LH Side (Early models)

35-0876 Ducati RH Side (Early models)



35-0883

35-0876

37-9683

37-9768 MC35 Adapter Set

*This Adapter Set Includes sizes to fit a wide range of Japanese and European models. Composite material prevents scratching.*

37-9712 MC35 Main Shaft And Quick Stop

37-9713 MC35 Honda Adapter 28.5mm

37-9714 MC35 Honda Adapter 31.5mm

37-9715 MC35 BMW Adapter 30.75mm

37-9717 MC35 BMW Adapter 53mm

37-9718 MC35 Ducati Adapter 41mm

37-9767 MC35 MV Augusta 43mm

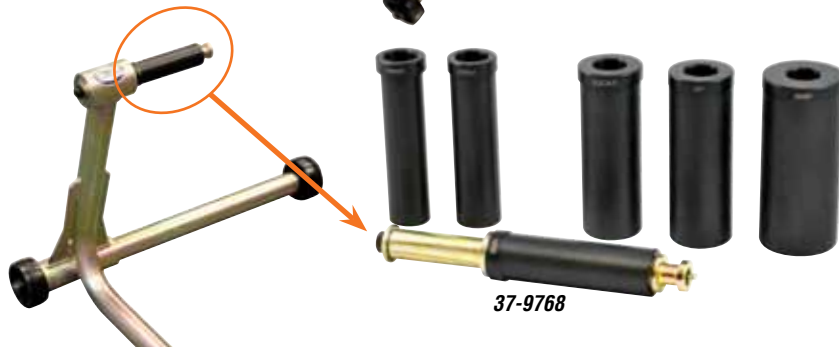

37-9768

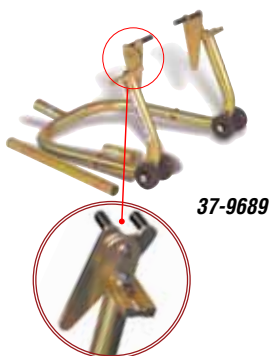

37-9689

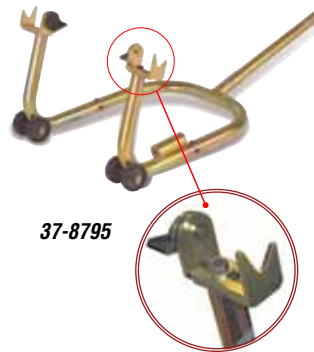

37-8795

## K&L MC40 UNIVERSAL FRONT WHEEL STAND

The MC40 heavy duty front end stand from K&L Supply features a pendulum type design which keeps the adapters in place every time you use it. Handle is removable and the adapters are adjustable from side to side for a more universal fit.

37-9689 K&L MC40 Universal Front Wheel Stand

## K&L MC45 UNIVERSAL SWINGARM STAND

Our MC45 heavy duty universal swingarm stand comes with fully adjustable adapters, and accommodates both spool and swingarm designs. The MC45 gives great stability in use; the removable handle allows freedom of movement after the bike is raised.

37-8795 K&L MC45 Universal Swingarm Stand

## HARLEY DAVIDSON® SWINGARM SUPPORTS FOR MC 45 REAR STAND

37-9669



37-9674

Sold 2 per kit.

37-9669 HD Swingarm Supports  
W/out Spool

37-9674 V-Rod Swingarm Supports

## K&L LIFT-GATE

Lift-Gate allows you to suspend the end on almost any type of vehicle, including Motorcycles, Snowmobiles, PWC, and ATV's. It can be used as a stand alone unit, or in conjunction with table style lifts to handle the longer wheelbases on todays motorcycles. The unit is constructed of 1.68" tubing and features three tie down points to secure the unit being serviced. It consists of three sections, and is UPS shippable. Overall assembled height is 79.5", width at base is 33.50". Increase the versatility of your service department.

**Note:** Will not work on Full Dressed Touring Motorcycles. **Winch Sold Separately.**

- 35-9940 K&L Lift-Gate
- 35-9952 Optional Winch, Cable included
- 35-9953 Winch Cable only



35-9940

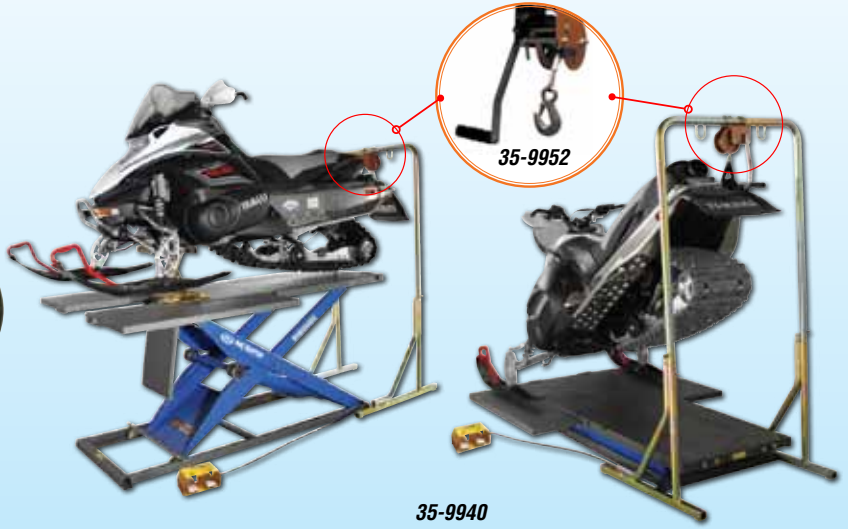

35-9940

## K&L MC360 CRATE LIFT

A versatile shop tool that enables one person to safely remove a motorcycle from the crate for assembly. Allows operator to lift up a max of 900 lbs. Four locking heavy duty casters that swivel 360° for improved mobility.

Can be used for:

- Tire Changing
- Fairing Repairs
- Front End Suspension Overhaul

- 35-9262 K&L MC360 Crate Lift

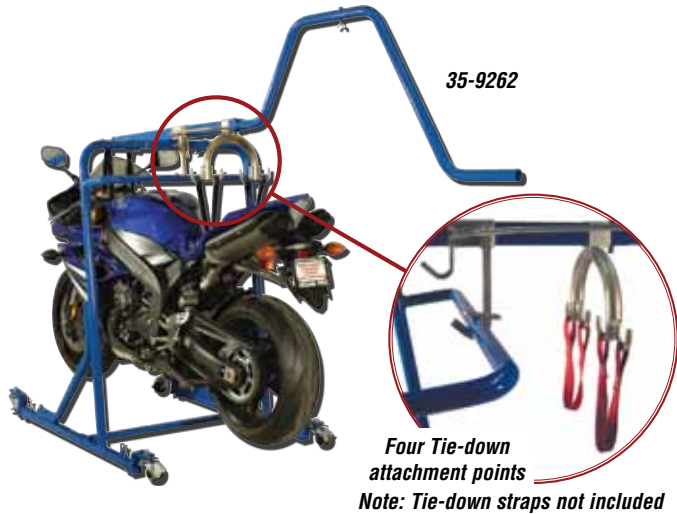

35-9262

Four Tie-down attachment points  
Note: Tie-down straps not included

## LOW RIDING RAMP

Raises front or rear wheel 3". giving proper height clearance when lifting any lowered motorcycle up onto floor style lifts.

- 35-0808 Low Riding Ramp

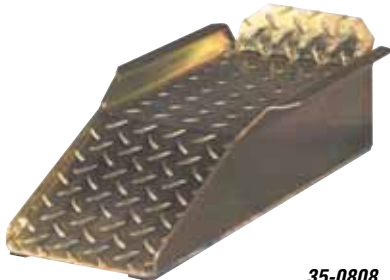

35-0808



## ROLLASTAND

The answer to bikes without centerstands! Works great for front or rear wheels; makes chain and belt maintenance easier. Just roll your bike onto the stand and place on its kickstand.

- 37-2240 Rollastand



37-2240



SHOP EQUIP & TOOLS

HARD PARTS

CARB & FUEL

IGNITION/ELECTRICAL

CONTROL

SUSPENSION

ACCESSORIES



SHOP EQUIP & TOOLS

HARD PARTS

CARB & FUEL

IGNITION/ELECTRICAL

CONTROL

SUSPENSION

ACCESSORIES



**K&L MC550 MULTI-LIFT**

Multi lift works with motorcycles and ATV's. Minimum height: 4.5", Maximum Height: 17"

Features include:

- 1200 Lb. capacity
- Locking caster wheels
- 16" padded contact area
- Foot operated locks
- Tie down points provided
- 4 ton bottle jack
- Powder Coat Finish

- 37-9885 K&L MC550 Multi-Lift
- 35-8623 Replacement Jack

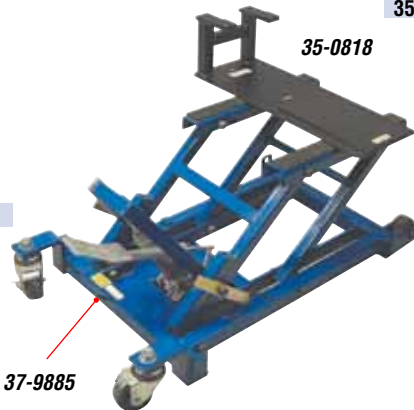

35-0818



**OPTIONAL ADAPTERS for MC550 MULTI-LIFT**

- 35-0817 Honda VT1100C/C2 Shadow/Shadow Ace 2000 and on only. Will not fit earlier years
- 35-0818 Honda GL1500C Valkyrie
- 35-0819 Kawasaki VN1500D/E/G/J/L/N Vulcan
- 35-0820 Yamaha XVZ13A Royal Star

**H-D® ADAPTERS for MC550 MULTI-LIFT**

- 35-0786 Sportster® Lift Adapter-This adapter allows clearance for the tight confines found between Sportster® frame rails and exhaust.
- 35-0806 Dyna® Lift Adapter-This adapter gives you the clearance needed when lifting a Harley-Davidson® Twin-Cam Dyna Glide® up onto MC550 Multi-Lift.



**K&L OUTBOARD MARINE ENGINE STAND**

K&L MARINE STAND is designed for today's 6 and 8 Cylinder Outboards. Patent Pending design features a 1000 pound capacity for the largest outboards. A corrosion resistant, pre-drilled zinc plated engine mounting board and large, easy rolling wheels make mounting and moving these motors safer, with a pin locked handle and included tool tray and outrigger attachment rounding out the package.

- 37-8429 Dreadnought Outboard Marine Motor Stand



**WATERCRAFT DOLLY**

This cart is ideal for storage or transport, and features a Heavy - Duty galvanized frame with 4 rugged 300lb casters. Two 4 ft. carpeted bunks tilt and adjust to 10", 12", 16" or 20" in width, and support up to 1000 lbs to make moving your PWC easy. Cart comes complete with all hardware and assembly instructions.

Dimensions:

- Assembled size - 34"W x 48"L x 19"H.
- Weight - 51 pounds

- 35-7854 Watercraft Dolly



**THE K&L "ALL-IN-ONE" - TIRE BEAD STARTER**



**35-9016** Tire Bead Starter



**3 IN 1 DOES IT ALL!**



**SEATS**



**BEADS**



**EXPANDS**

**"Cheetah CH-5" TIRE BEAD SEATER**

5-gallon Bead Seater with ASME certified tank for commercial use on ATV and motorcycle tires. Seats tire beads easily.

**Specifications:**  
18" wide x 22" length x 11" height 23 lbs

**35-9903** Tire Bead Seater



**35-9903**



**TIRE BEADER**



This solid rubber donut goes between tire and rim. As tire is inflated, the opposite bead (lip of tire) will seat, then the side of the rim with the rubber donut will begin to seat, pushing the rubber donut off the rim. Ideal for low profile tires, radial tires and safety rims. Sold each.

**35-5211** 16 - 17" Tires

**35-5212** 18 - 19" Tires

**"Cheetah CH-2" TIRE BEAD SEATER**

2-gallon Bead Seater with ASME certified tank for use on ATV, lawn & garden, Golf carts and motorcycle tires. Seats tire beads easily.

**Specifications:**  
6.5" wide x 17" length x 8" height 17 lbs

**35-8162** Tire Bead Seater



**35-8162**

**TIRE BEAD EXPANDER**



Slips easily over tire. To use, draw strap tight and lock with two rings, apply air pressure. Beads will seal against rim with air pressure. Tough red nylon cover, neoprene inner tube.

**35-8889** Tire Bead Expander

**MOTION PRO BEAD POPPER™**

Bead Popper makes tire removal easy and scratched rims a thing of the past. Bead Popper can be used with wheel mounted or removed. Made of a durable plastic, not for use on ATV's.

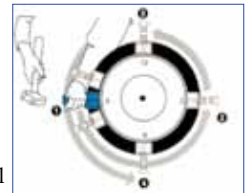

**35-1000** Motion Pro Bead Popper™



**35-1000**

SHOP EQUIP & TOOLS

HARD PARTS

CARB & FUEL

IGNITION/ELECTRICAL

CONTROL

SUSPENSION

ACCESSORIES